

## Operating Instructions

### Laboratory Furnaces (Muffle Furnaces)

L .../... LE .../... LT .../... LV .../... LVT .../... -  
SKM -SW

M01.1060 ENGLISCH

Original instructions

■ Made  
■ in  
■ Germany

[www.nabertherm.com](http://www.nabertherm.com)

---

### **Copyright**

© Copyright by  
Nabertherm GmbH  
Bahnhofstrasse 20  
28865 Lilienthal  
Federal Republic of Germany

Reg: M01.1060 ENGLISCH  
Rev: 2022-12

No responsibility is accepted for the correctness of this information. We reserve the right to make technical alterations.

<b>1</b>	<b>Introduction .....</b>	<b>5</b>
1.1	Key to the Symbols and Warning Terminology Used in Warning Messages .....	5
1.2	Product Description.....	8
1.3	Overview of the Complete System.....	10
1.4	Safeguarding against Dangers from Excess Temperatures .....	18
1.5	Key to the Model Names.....	19
1.6	Scope of Delivery.....	20
<b>2</b>	<b>Specifications .....</b>	<b>21</b>
<b>3</b>	<b>Warranty and Liability .....</b>	<b>27</b>
<b>4</b>	<b>Safety .....</b>	<b>28</b>
4.1	Defined Application .....	28
4.2	Safety Concept for Furnace Model LV(T) ..../.....	29
4.3	Requirements for the Furnace Operator .....	31
4.4	Requirements for the Operating Personnel.....	31
4.5	Protective Clothing.....	32
4.6	Basic Measures During Normal Operation .....	32
4.7	Basic Measures in Case of Emergency .....	33
4.7.1	What to Do in an Emergency .....	33
4.8	Basic Measures for Servicing and Maintenance.....	33
4.9	Environmental Regulations .....	34
4.10	General Risks with the Furnace.....	35
<b>5</b>	<b>Transportation, Installation and Initial Start-Up.....</b>	<b>36</b>
5.1	Delivery.....	36
5.2	Unpacking .....	38
5.3	Transport Securing Device/Packaging .....	39
5.4	Constructional and Connection Requirements .....	39
5.4.1	Installation (Furnace Location).....	39
5.5	Assembly, Installation, and Connection.....	41
5.5.1	Connecting the Furnace to the Power Supply .....	41
5.5.2	Assembly of a Vent.....	43
5.5.3	Venting Exhaust Fumes .....	45
5.5.4	Insertion of the Base Plate .....	46
5.5.5	Installing the Scale on the L(T)...../...../SW Model .....	47
5.5.6	Initial Start-Up .....	48
5.5.7	Recommendations for Heating Up the Furnace for the First Time .....	49
<b>6</b>	<b>Operation .....</b>	<b>49</b>
6.1	Turning on the Controller/Furnace.....	49
6.2	Turning off the Controller/Furnace .....	49
6.3	Controller 500 Product Line.....	50
6.4	Operating Controller R7 .....	50
6.5	Over-Temperature Limiter with Manual Reset and Adjustable Cutout Temperature (Additional Equipment).....	53
6.6	Loading/Charging .....	54
6.7	Inserting the base plate and/or catch basin (accessories).....	55
6.8	Fresh Air Valve .....	56
6.9	Stackable Sagger (Accessories).....	57

<b>7</b>	<b>Servicing, Cleaning, and Maintenance .....</b>	<b>58</b>
7.1	Furnace Insulation.....	59
7.2	Shutting the System Down for Maintenance.....	60
7.3	Regular Maintenance of the Furnace.....	61
7.4	Regular Maintenance Tasks – Documentation.....	62
7.5	Maintenance Table Key .....	62
7.6	Cleaning Products .....	62
<b>8</b>	<b>Malfunctions .....</b>	<b>63</b>
8.1	Error Messages of the Controller .....	64
8.2	Warnings of the Controller.....	66
8.3	Malfunctions of the Switchgear .....	69
8.4	Replacing a Fuse .....	70
8.4.1	Fuse Located Outside the Switchgear .....	70
8.5	Separate the Snap-In Coupling (Plug) from the Furnace Housing .....	72
<b>9</b>	<b>Spare Parts/Wearing Parts .....</b>	<b>72</b>
9.1	Replacing a Thermocouple.....	73
9.2	Replacing the Heating Plates and Internal Furnace Insulation (Fiber Muffle).....	74
9.3	Replacement/Readjustment of the Door Insulation Structure .....	74
9.4	Repairing the Insulation .....	75
9.5	Electrical Schematics/Pneumatic Schematics .....	75
9.6	Additional Equipment .....	76
9.6.1	Gas Supply System (Accessories).....	76
9.6.2	Operation of Compressed Gas Containers .....	77
<b>10</b>	<b>Nabertherm Service.....</b>	<b>79</b>
<b>11</b>	<b>Shut-Down, Dismantling, and Storage.....</b>	<b>79</b>
11.1	Environmental Regulations .....	79
11.2	Transportation/Return Transportation .....	80
<b>12</b>	<b>Declaration of Conformity .....</b>	<b>81</b>
<b>13</b>	<b>For Your Notes .....</b>	<b>82</b>

# 1 Introduction

These documents are intended only for buyers of our products and may not be copied or disclosed to third parties without our written consent. (Law governing copyright and associated protective rights, German Copyright Law from Sept. 9, 1965)

Nabertherm GmbH owns all rights to drawings, other documents and authorizations, also in case of applications for protective rights.

All the figures in the instructions have a descriptive character; in other words, they do not represent the exact details of the furnace.

## 1.1 Key to the Symbols and Warning Terminology Used in Warning Messages



### Note

The following operating instructions set forth specific warnings to highlight the residual risks that cannot be avoided when operating the equipment. These residual risks include hazards to personnel/product/equipment and the environment.

The symbols used in the operating instructions are primarily intended to draw attention to the safety instructions!

The respective symbols cannot replace the text contained in the safety instructions. The text must therefore always be read in full!

Graphic symbols correspond to **ISO 3864**. According to the **American National Standards Institute (ANSI) Z535.6** standard, the following warning messages and terminology are used in this document:





The general hazard symbol, in conjunction with the warning words **CAUTION**, **WARNING** and **DANGER**, warns of the risk of serious injury.

The textual explanations associated with the general hazard symbol, particularly if this appears on the device, must always be observed in order to obtain instructions on how to avoid hazards and prevent injury or death.




<b>NOTICE</b>	Indicates a hazardous situation leading to damage to or destruction of the equipment.
<b>CAUTION</b>	Indicates a hazardous situation that could result in minor or moderate injury.
<b>WARNING</b>	Indicates a hazardous situation that could result in death or serious or irreversible injury.
<b>DANGER</b>	Indicates a hazardous situation that will result in immediate death or serious injury.

### Warning Message Structure:

All warning messages are structured as follows

	 <sup>1</sup> <b>WARNING</b> <sup>2</sup>
	<ul style="list-style-type: none"> <li>• <b>Type and source of hazard</b><sup>3</sup></li> <li>• <b>Consequences of non-observance</b><sup>3</sup></li> <li>• <b>Action to avert hazard</b><sup>3</sup></li> </ul>

or

		
4	<ul style="list-style-type: none"> <li>• Type and source of hazard<sup>3</sup></li> <li>• Consequences of non-observance<sup>3</sup></li> <li>• Action to avert hazard<sup>3</sup></li> </ul>	5

Item	Name	Explanation
1	Safety alert symbol	Indicates risk of injury
2	Signal word	Classifies the hazard
3	Safety messages	<ul style="list-style-type: none"> <li>• Type and source of hazard</li> <li>• Potential consequences if not observed</li> <li>• Measures/prohibitions</li> </ul>
4	Graphical symbols (optional) according to ISO 3864:	Consequences, measures or prohibitions
5	Graphical symbols (optional) according to ISO 3864:	Rules or prohibitions

#### Information Symbols in the Instructions:



##### Note

Below this symbol you will find instructions and particularly useful information.



##### Rule - Rule Sign

This symbol draws attention to important rules that must be observed. Rule signs protect people against injury and show what is to be done in certain situations.



##### Rule – Important Information for Operators

This symbol draws the operator's attention to important information and operating instructions that must be observed.



##### Rule – Important Information for Maintenance Personnel

This symbol draws the maintenance personnel's attention to important operating and maintenance instructions (service) that must be observed.



##### Rule – Pull Out the Power Plug

This symbol tells the operator to pull out the power plug.

**Rule – Lift only with Several People**

This symbol draws the personnel's attention to the fact that this device may only be lifted and moved to its final destination by several people.

**Warning – Hot Surface, Do Not Touch**

This symbol warns the operator that the surface is hot and should not be touched.

**Warning – Danger of Electric Shock**

This symbol warns the operator that there is a risk of an electric shock if the following warnings are not heeded.

**Warning – Risk of Device Toppling Over**

This symbol tells the operator that there is a risk of the device toppling over if the following warnings are not heeded.

**Warning – Suspended Load**

This symbol warns the operator of potential dangers of suspended loads. Working below a suspended load is strictly forbidden. Ignoring this can lead to fatal injury.

**Warning – Danger if Heavy Loads are Lifted**

This symbol warns the operator of the potential dangers of lifting heavy loads. Ignoring this can lead to injury.

**Warning – Risk to the Environment**

This symbol warns the operator of the risk to the environment if the following information is not heeded. The operator must ensure that national environmental regulations are observed.

**Warning – Fire Danger**

This symbol warns operators of the danger of fire if the following information is not followed.

**Warning – Risk of Explosive Substances or Explosive Atmosphere**

These symbols warn the operator of explosive substances or an explosive atmosphere

**Prohibited – Important Information for Operators**

This symbol warns the operator that water or cleaning products must NOT be poured over the objects. A high-pressure cleaning device must also not be used.

### Warning Signs on the Furnace:



#### Warning – Hot Surface, Danger of Burning – Do Not Touch

You may not always realize that surfaces, such as furnace components, furnace walls, doors and materials, and even liquids are hot. Do not touch the surface.



#### Warning – Danger of Electric Shock!

Warning, dangerous electric voltage

## 1.2 Product Description

**Laboratory Furnaces** are attractive thanks to their many advantages. These furnaces are all-rounders for research and laboratory applications. They are made from expertly finished, high-quality materials and are easy to operate. These furnaces are optimally designed for incinerating and heat treatment. The very best insulation materials permit energy-saving operation and fast heating times thanks to low heat storage and thermal conductivity. Laboratory furnaces attain furnace chamber temperatures of max. 1100 °C (2012 °F), 1200 °C (2192 °F), 1300 °C (2372 °F) or 1400 °C (2552 °F).

#### Other Characteristics of this Product are:

- Double-wall housing means low outer temperatures and solid stability. All furnaces (not for models LE) have housings made of textured stainless steel sheet
- Good temperature uniformity provided by special air supply and exhaust system for models LV/LVT .../.... For models LV/LVT .../... the system delivers more than 6 air changes a minute. The incoming air is pre-heated, so that a good temperature uniformity is ensured
- There are furnaces with drop-down doors or lift doors
- Ceramic heating plates with integrated heating wire, protected against splattering and exhaust-air for models L/LT .../... and LV/LVT .../...
- Model L/LT .../.../SW with scale and software (VCD-software) for annealing loss specifications
- All the models are equipped with a controller which provides considerable safety against operator mistakes. The furnace chamber temperature is measured and regulated by a long-life thermocouple (NiCrSi-NiSi Tmax < 1200 °C or PtRh-Pt Tmax > 1200 °C)
- Exclusive use of insulation materials without categorization according to EC Regulation No 1272/2008 (CLP). This explicitly means that aluminosilicate wool, also known as “refractory ceramic fiber” (RCF), which is classified and possibly carcinogenic, is not used.



### **Additional Equipment**

- Over-temperature limiter with manual reset as over-temperature protection for the furnace and the charge
- Protective gas connection to purge with non-flammable protective or reaction gases
- Manual or automatic gas supply system
- Process control and documentation via VCD software package for monitoring, documentation and control

### **Accessories**

- Vent, vent with fan or catalytic converter (depending on model)
- Base plates and catch basins to protect of the furnace and to enable easy charging
- Rectangular container, stackable for charging on several levels

### 1.3 Overview of the Complete System

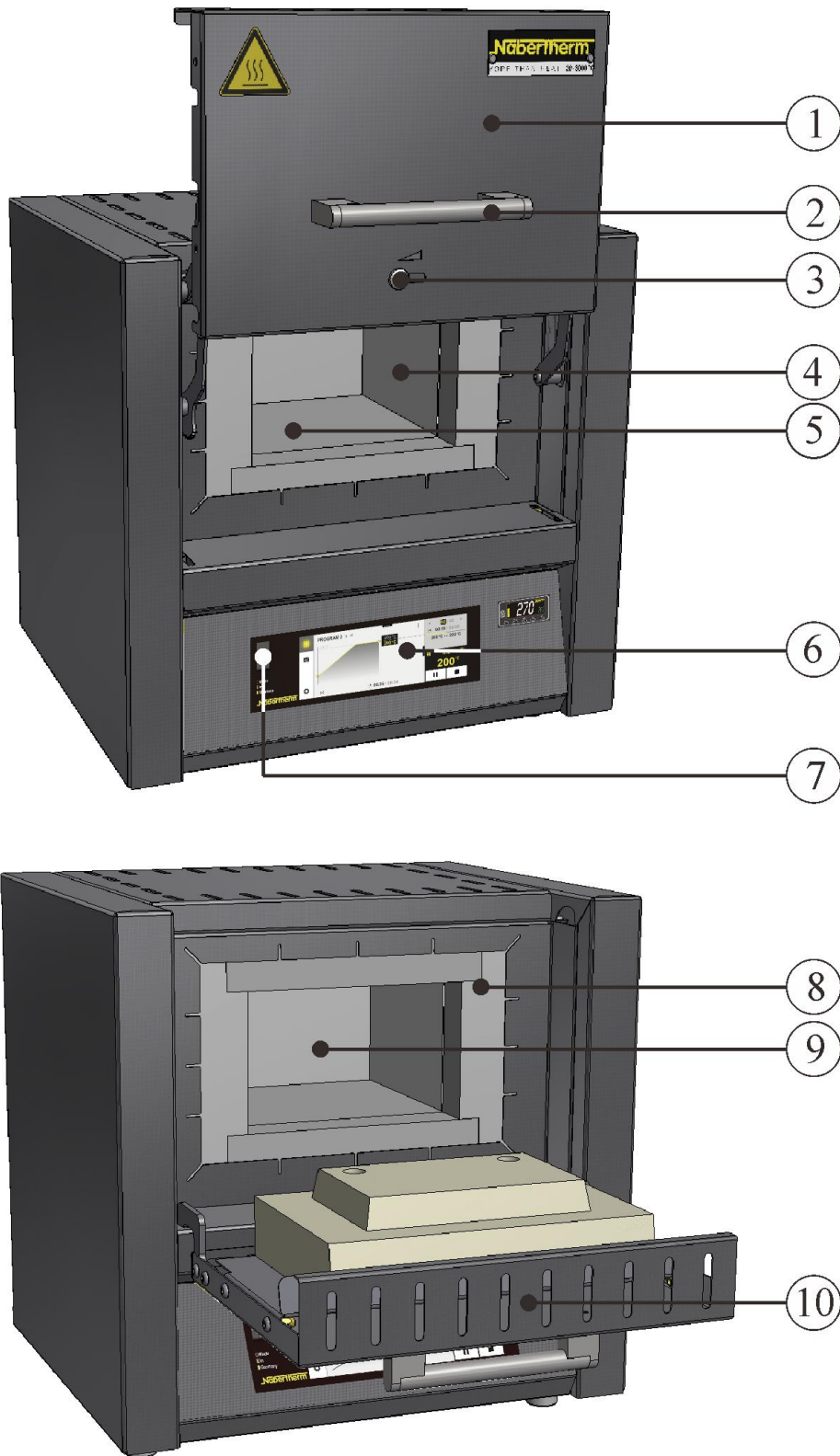


Fig. 1: Example: Overview of model LT ../11-12 (lift door) and L ../11-12 (folding door; illustration similar)

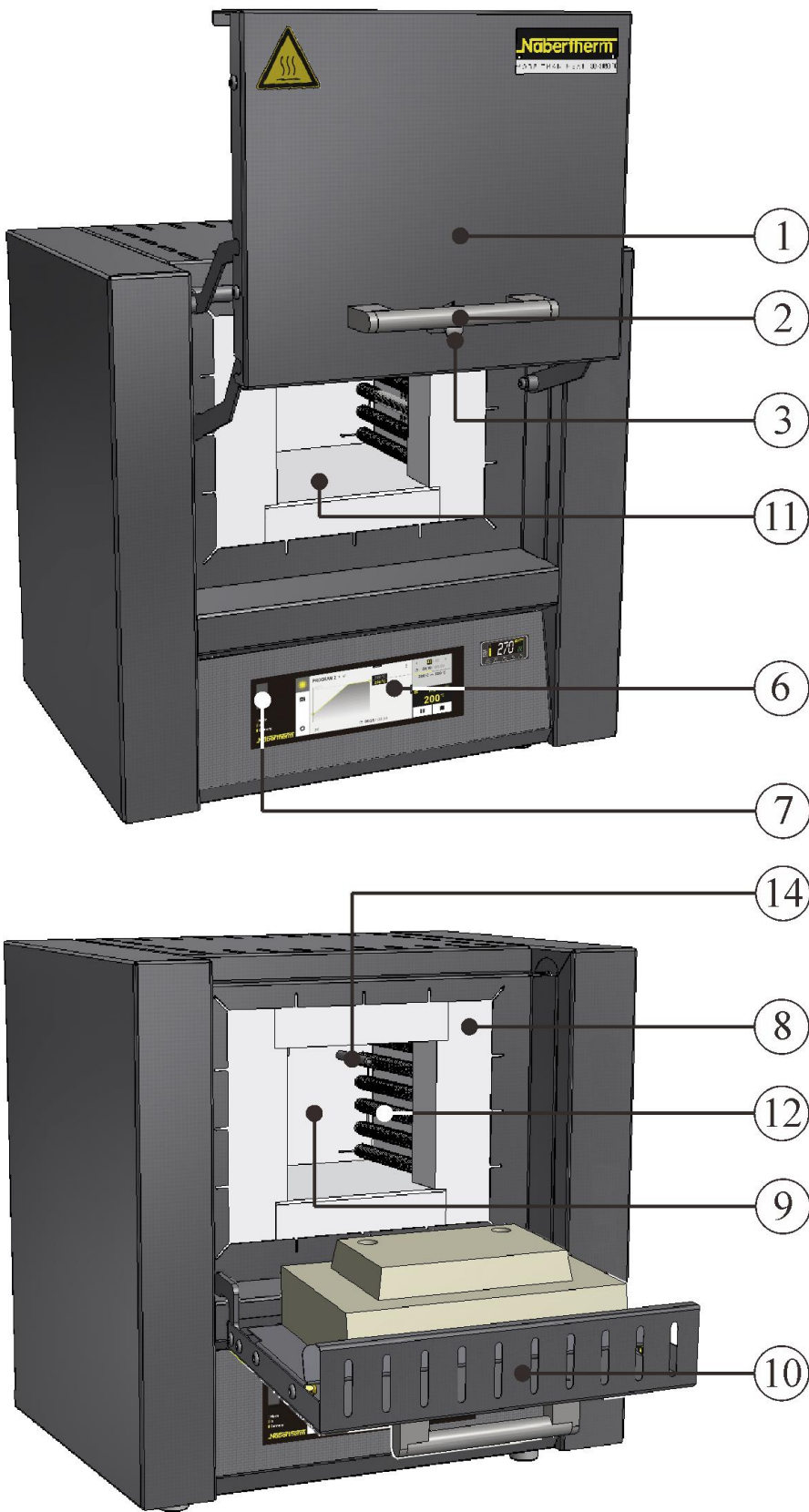


Fig. 2: Example: Overview of model LT ../13 (lift door) and L ../13 (folding door; illustration similar)

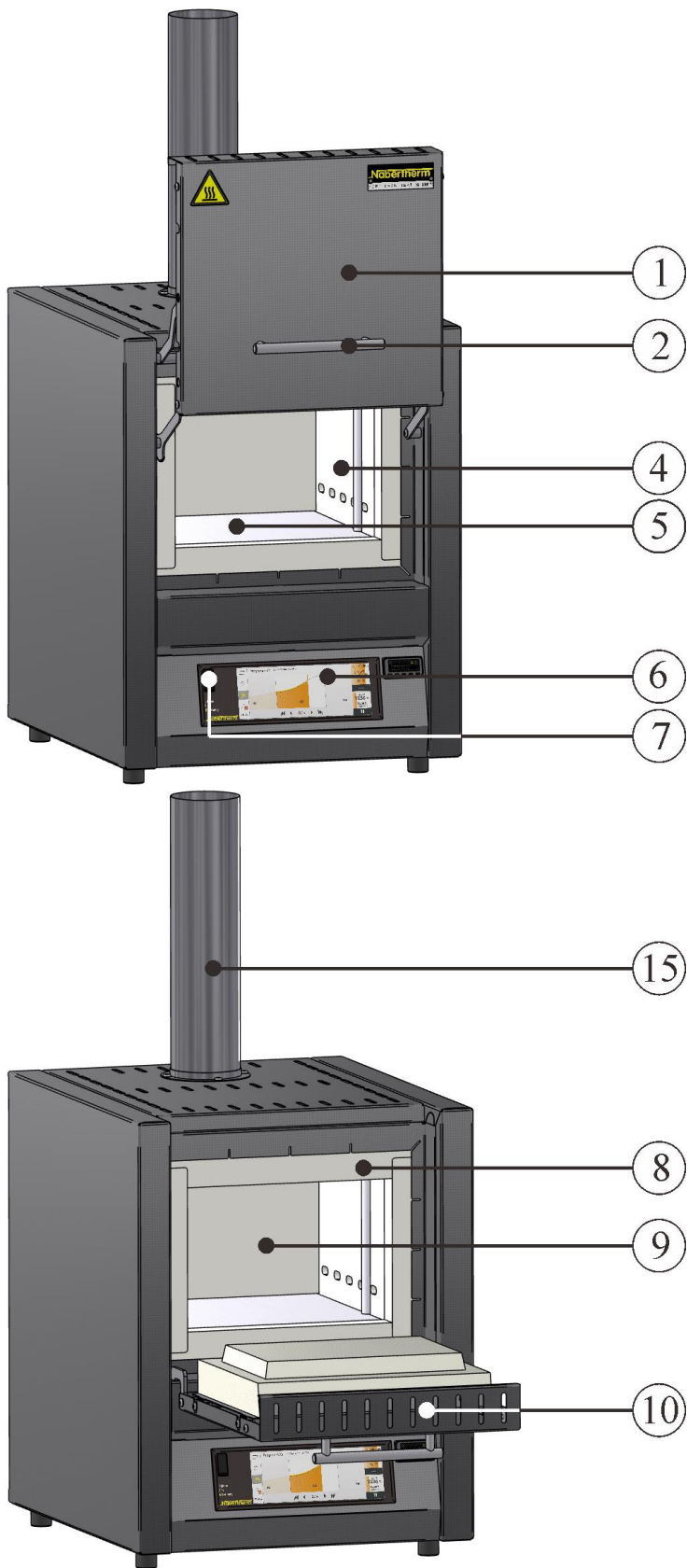


Fig. 3: Example: Overview of model LVT ../11 (lift door) and LV ../11 (folding door; illustration similar)

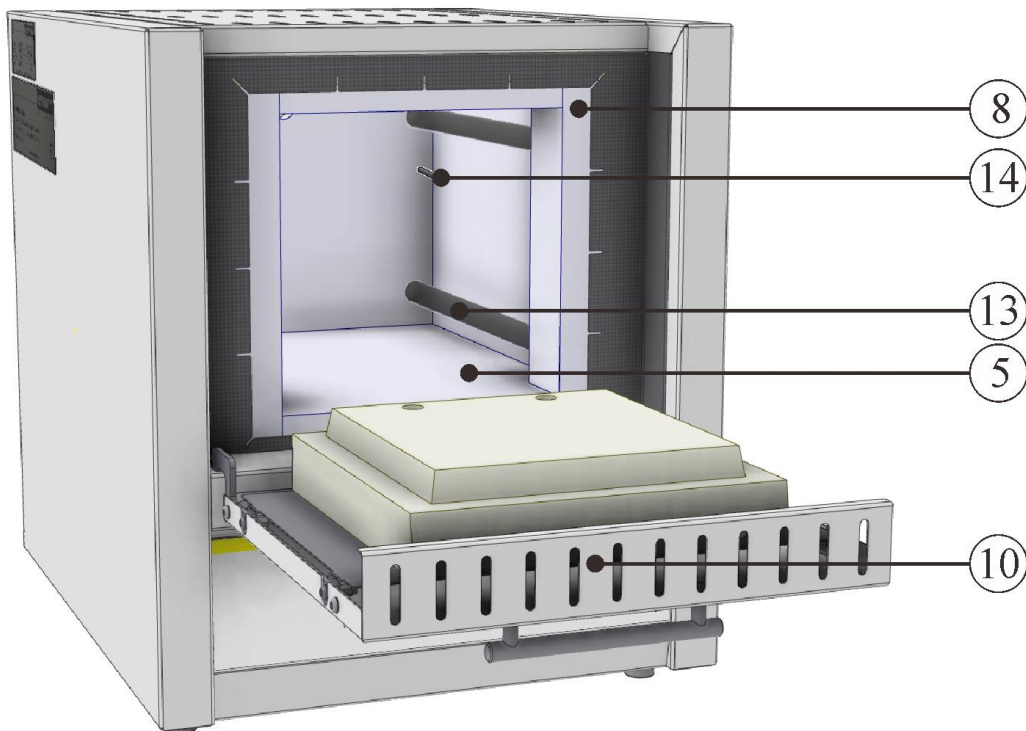
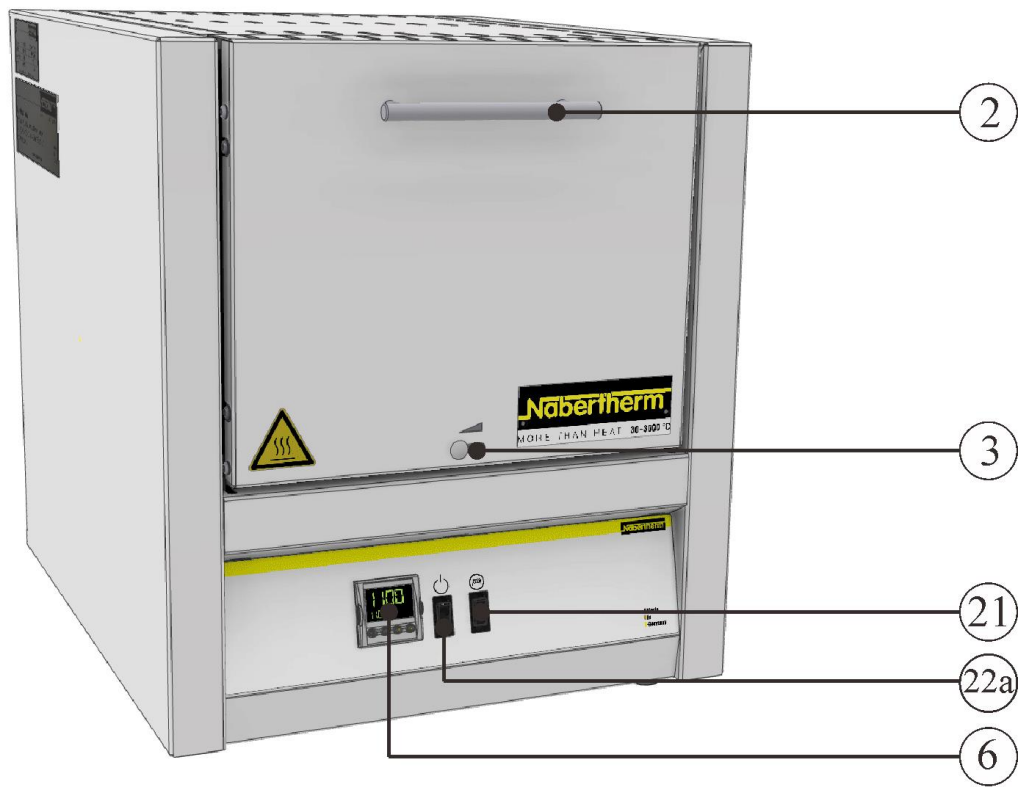


Fig. 4: Example: Overview of model LE ../14 (folding door; illustration similar)

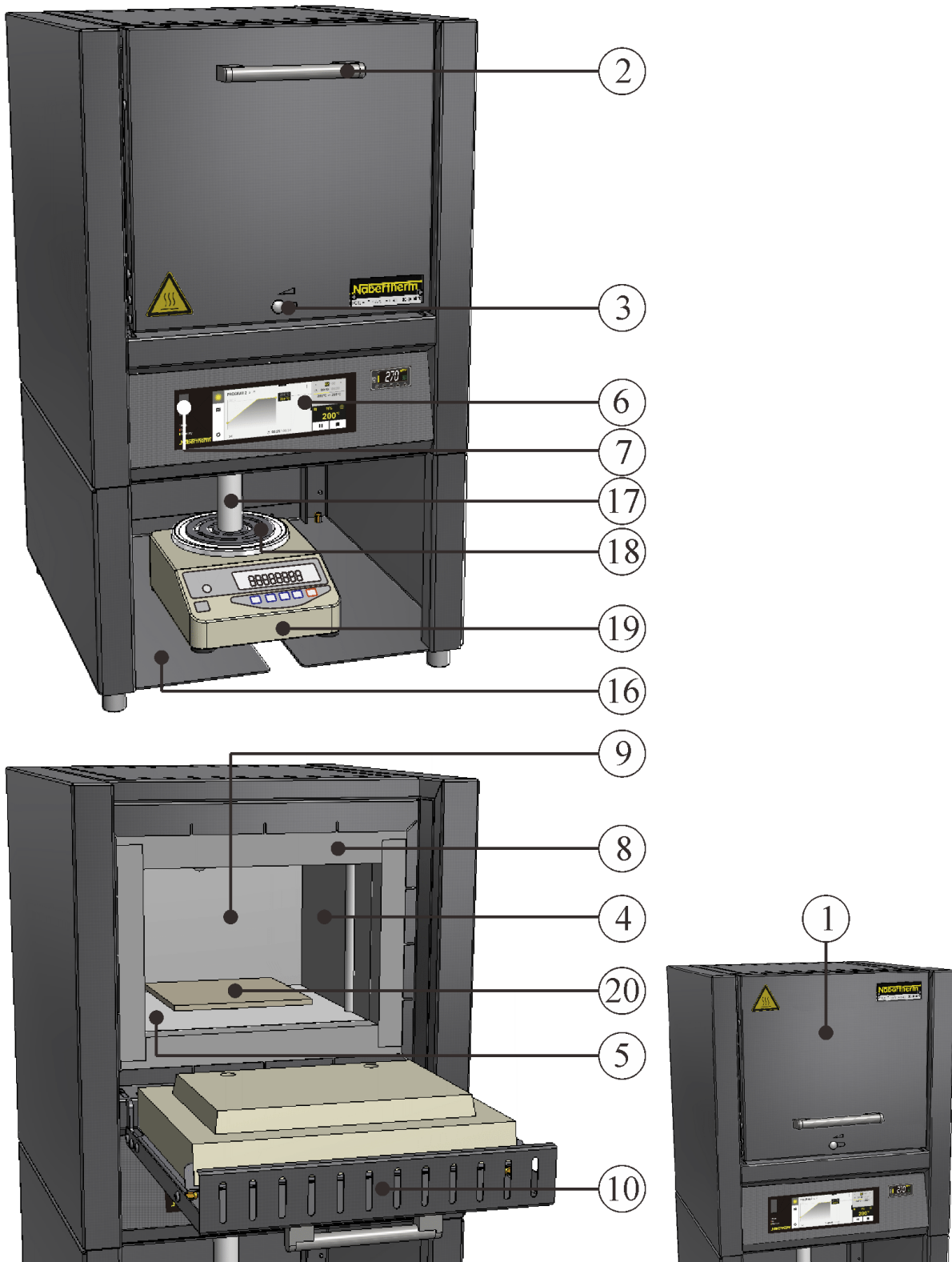


Fig. 5: Example: Overview of weighing furnace, including scale, model L .././SW (folding door) and LT .././SW (lift door; illustration similar)

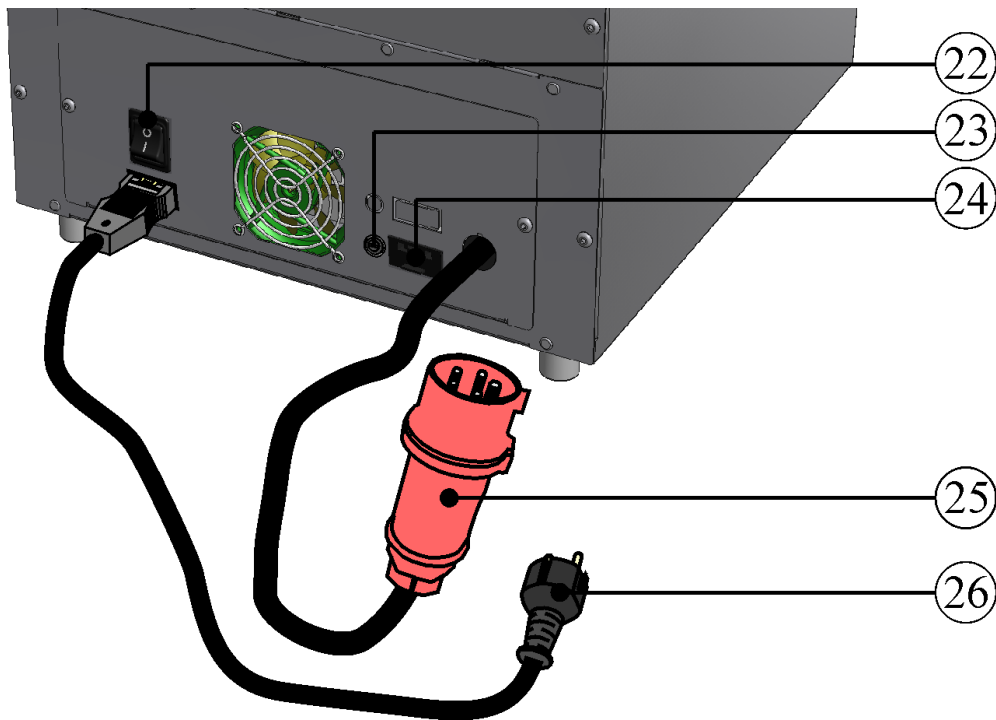


Fig. 6: Laboratory furnace (muffle furnace), rear view (illustration similar)

No.	Designation
1	Lift door
2	Handle
3	Air inlet slider for regulating the fresh air
4	Ceramic heating plates with integrated heating element, protected against splashing water and exhaust gas
5	Insulation of unclassified fiber material
6	Controller
7	USB interface
8	Shroud insulation
9	Furnace chamber
10	Folding door
11	Multi-layered insulation with robust refractory bricks in the furnace chamber
12	Heating elements on supporting tubes
13	Heating elements in quartz glass tubes
14	Thermocouple
15	Exhaust air plant
16	Base
17	Ceramic stamp

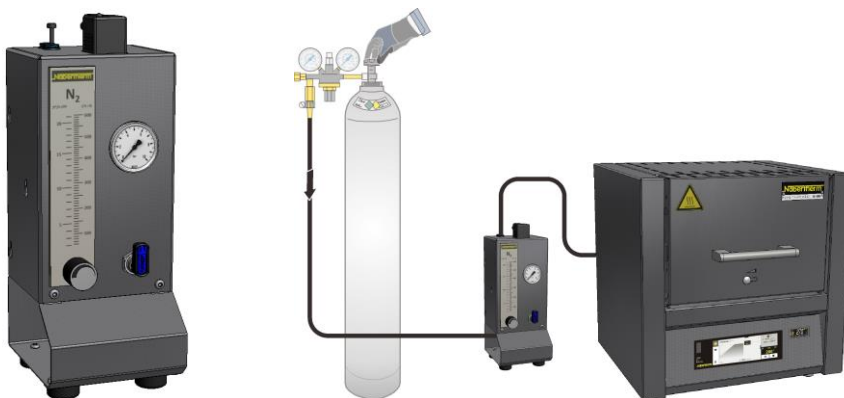
No.	Designation
18	Receptacle stamp
19	Scale EW-...
20	Supporting plate in the furnace chamber
21	Heating (ON / OFF)
22	Power switch with integrated fuse (for switching the furnace on / off)
22a	Power switch (for switching the furnace on / off)
23	Fuse for additional power connection (for accessories)
24	Additional power connection (for accessories)
25	Power plug CEE (16 A and above)
26	Power plug (up to 3600 watts) with snap-in coupling

### Additional Equipment



Over-temperature limiter with manual reset as over-temperature protection for the furnace and the charge

Fig. 7: Example (similar to picture)



**Protective gas connection to purge with non-flammable protective or reaction gases.**

Gas supply system for non-flammable protective or reactive gas with shutoff valve and flow meter with regulator valve, piped and ready to connect (similar to picture)

Fig. 8: Example (similar to picture)



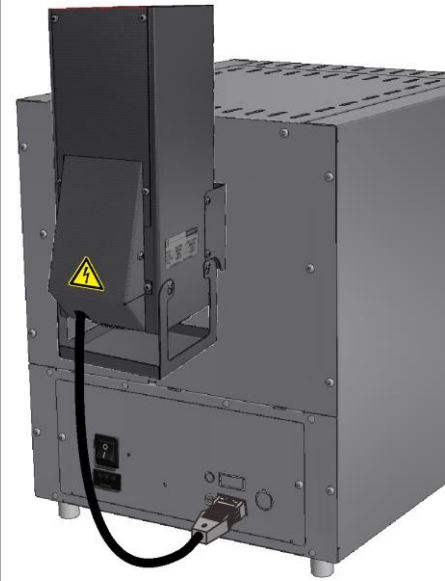
## Accessories



**Chimney** for connection to an exhaust pipe.



**Chimney with fan**, to remove exhaust gas from the furnace better. The B510 – P580 controllers can be used to activate the fan automatically (not for models L(T) 15.., L 1/12, LE 1/11, LE 2/11).\*



**Catalytic converter with fan** for removal of organic components from the exhaust air. Organic components are catalytically oxidized at about 600 °C, broken into carbon dioxide and water vapour. Irritating odors are thus largely eliminated. The B510 – P580 controllers can be used to switch the catalytic converter automatically (not for models L(T) 15.., L 1/12, LE 1/11, LE 2/11).\*

\* Note: If other controller types are used an adapter cable for connection to mains supply has to be ordered separately. The device will be activated by plugging in the socket.

Fig. 9: Example: (similar to picture)

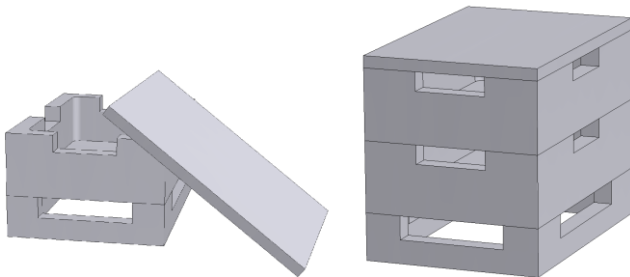
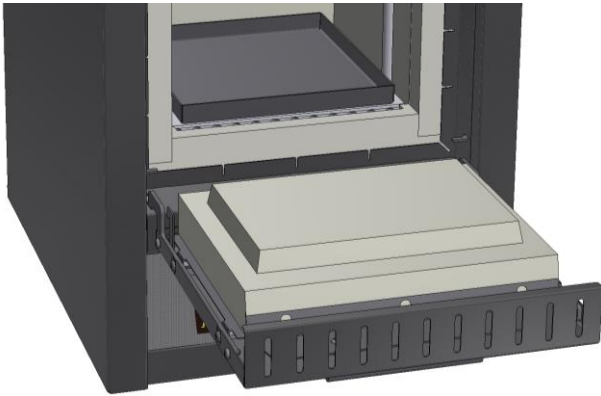


Fig. 10: Rectangular saggars with lid (similar to picture)

### Rectangular saggars

For optimum utilization of the furnace chamber, the material is placed in ceramic saggars. Up to three saggars can be stacked in the furnace. The saggars have slits to allow the air to circulate. The top saggars can be closed with a ceramic lid.



Base plates (made of ceramic) and catch basins (made of ceramic or steel depending on the application) to protect the furnace and enable easy charging.

Fig. 11: Base plates and catch basins (similar to picture)



#### Charging rack for furnace model LV(T)



Charging rack with closed or perforated trays for loading the furnace in two levels incl. holder for inserting/removing the trays up to a max. temperature of 800°C and a max. loading weight of 2 kg for the L(T) 9/11 respectively 3 kg for the L(T) 15/11

Fig. 12: Charging rack (similar to picture)

## 1.4 Safeguarding against Dangers from Excess Temperatures

Over-temperature limiters and over-temperature limiters with automatic reset to protect against over-temperature in the furnace are available for Nabertherm GmbH furnaces either as a standard feature (depending on the model series) or as additional equipment (customized design).

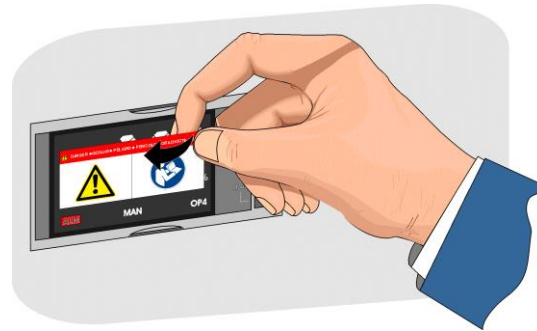
Over-temperature limiters and over-temperature limiters with automatic reset monitor the furnace temperature. The display shows the most recently set cut-off temperature. If the furnace temperature rises above the pre-set cut-off temperature, the heating is shut down to protect the furnace, the charge and/or the operating equipment.

	 <b>DANGER</b>
	<ul style="list-style-type: none"> <li>• <b>Danger caused by incorrectly entered cut-off temperature at the over-temperature limiter/over-temperature limiter with motor driven reset</b></li> <li>• <b>Risk of fatal injury</b></li> <li>• If, as a result of over-temperature from the charge and/or the operating equipment, a charge is likely to be damaged at this pre-set cut-off temperature of the over-temperature limiter/over-temperature limiter with motor driven reset, or if the charge itself becomes a source of danger for the furnace or its surroundings, the cut-off temperature must be reduced on the over-temperature limiter/over-temperature limiter with motor driven reset to the maximum permissible value.</li> </ul>

Read the operating instructions of the over-temperature limiter/over-temperature limiter with automatic reset before starting the furnace. The safety sticker must be removed from

the over-temperature limiter/over-temperature limiter with automatic reset. When a change is made in the heat treatment program, the maximum permissible cut-off temperature (alarm trigger temperature) on the over-temperature limiter/over-temperature limiter with automatic reset must be checked or re-entered.

Depending on the physical characteristics of the furnace, we recommend that you set the maximum target temperature of the heating program in the controller between 5 °C and 30 °C below the trigger temperature of the over-temperature limiter/over-temperature limiter with automatic reset. This prevents unwanted triggering of the over-temperature limiter/over-temperature limiter with automatic reset.



Description and function, see the Operating Instructions of the over-temperature limiter/over-temperature limiter with automatic reset.

Fig. 13: Removing the sticker (similar to picture)

## 1.5 Key to the Model Names

Example	Explanation
LT 9/11/SKM	<b>L</b> = Laboratory furnace with drop-down door <b>LE</b> = Laboratory furnace economy series <b>LT</b> = Laboratory furnace with lift door <b>LV</b> = Laboratory incinerator with drop-down door <b>LVT</b> = Laboratory incinerator with lift door
LT 9/11/SKM	<b>1</b> = 1-liter furnace chamber (volume in l) <b>2</b> = 2-liter furnace chamber (volume in l) <b>3</b> = 3-liter furnace chamber (volume in l) <b>4</b> = 4-liter furnace chamber (volume in l) <b>5</b> = 5-liter furnace chamber (volume in l) <b>6</b> = 6-liter furnace chamber (volume in l) <b>9</b> = 9-liter furnace chamber (volume in l) <b>14</b> = 14-liter furnace chamber (volume in l) <b>15</b> = 15-liter furnace chamber (volume in l) <b>24</b> = 24-liter furnace chamber (volume in l) <b>40</b> = 40-liter furnace chamber (volume in l) <b>60</b> = 60-liter furnace chamber (volume in l)
LT 9/11/SKM	<b>11</b> = Tmax 1100 °C (2012 °F) <b>12</b> = Tmax 1200 °C (2192 °F) <b>13</b> = Tmax 1300 °C (2372 °F) <b>14</b> = Tmax 1400 °C (2552 °F)
LT 9/11/SKM	<b>SKM</b> = Furnace chamber made of ceramic muffle <b>SW</b> = Scale furnace with support frame and scale

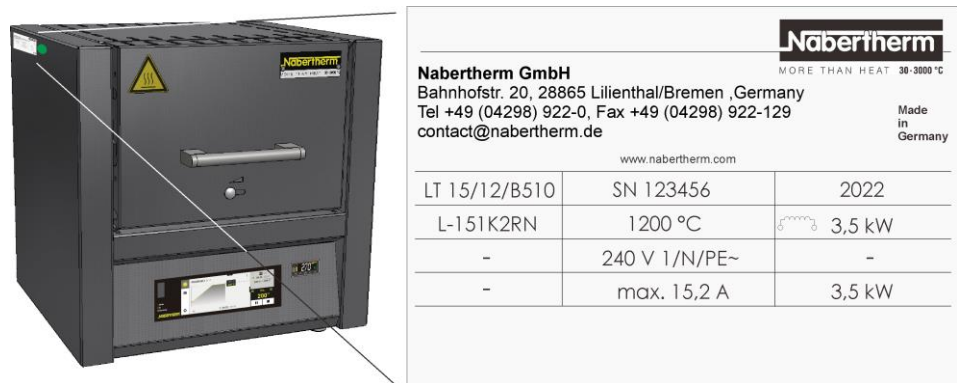


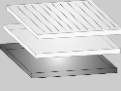






Fig. 14: Example: Model designation (type plate)

## 1.6 Scope of Delivery

The scope of delivery includes:

	Furnace components	Quantity	Comment
	Laboratory furnace <sup>1)</sup>	1 x	Nabertherm GmbH
	Power cable <sup>1)</sup>	1 x	Nabertherm GmbH
	Vent <sup>1)2)</sup> Vent with fan <sup>1)2)</sup> Catalytic converter <sup>1)2)</sup>	1 x	Nabertherm GmbH
	Ceramic ribbed plate Ceramic ceramic catch basin Steel catch basin	4)	Nabertherm GmbH
	Base Plate <sup>1)</sup>	3)	Nabertherm GmbH
	Gas supply system <sup>2)</sup>	1 x	Nabertherm GmbH
	Scale <sup>2)</sup>	1 x	Nabertherm GmbH
	Process documentation VCD software package <sup>1)2)</sup>	1 x	Nabertherm GmbH
	Other components, variable depending on the particular furnace	- - -	Consult the shipping papers

	Document type	Quantity	Comment
	Instruction Manual Laboratory Furnace <sup>1)</sup>	1 x	Nabertherm GmbH
	Operating Instructions for Controller <sup>1)</sup>	1 x	Nabertherm GmbH
	Operating Instructions gas supply system <sup>1)</sup>	1 x	Nabertherm GmbH
	Operating Instructions VCD software package <sup>1)</sup>	1 x	Nabertherm GmbH
	Other documents, variable depending on the particular furnace	- - -	

<sup>1)</sup>in scope of delivery depends on design/furnace model

<sup>2)</sup>in scope of delivery depend on need, see shipping papers

<sup>3)</sup>quantity depends on furnace model

<sup>4)</sup>quantity depends on on need, see shipping papers



### Caution

Make sure that all documents are carefully stored. All the functions of this furnace were tested during manufacturing and prior to shipping.



### Note

The documents included do not always contain the electrical schematics and pneumatic diagrams.

If you need the respective diagrams, they can be ordered from Nabertherm Service.

## 2 Specifications



Electrical specifications are on the type plate located on the side of the furnace.

### Muffle Furnace

Model Flap door	Tmax °C	Inner dimensions in mm			Volum e in l	Outer dimensions in mm			Connected load kW	Weig ht in kg	Minutes to Tmax <sup>2</sup>
		w	d	h		W	D	H			
L 3/11	1100	160	140	100	3	385	330	405	1,3	21	45
L 5/11	1100	200	170	130	5	385	390	460	2,6	27	50
L 9/11	1100	230	240	170	9	415	455	515	3,3	35	65
L 15/11	1100	230	340	170	15	415	555	515	3,5	43	75
L 24/11	1100	280	340	250	24	490	555	580	4,9	52	70
L 40/11	1100	320	490	250	40	530	705	580	6,5	70	80

L 1/12	1200	90	115	110	1	290	280	430	1,6	15	25
L 3/12	1200	160	140	100	3	385	330	405	1,3	21	50
L 5/12	1200	200	170	130	5	385	390	460	2,6	27	60
L 9/12	1200	230	240	170	9	415	455	515	3,3	35	80
L 15/12	1200	230	340	170	15	415	555	515	3,5	43	100
L 24/12	1200	280	340	250	24	490	555	580	4,9	52	85
L 40/12	1200	320	490	250	40	530	705	580	6,5	70	100

<sup>2</sup> If connected at 230 V 1/N/PE resp. 400 V 3/N/PE

### Muffle Furnace

Model Lift door	Tmax	Inner dimensions in mm			Volume	Outer dimensions in mm			Connecte d load	Weig ht	Minute s
	°C	w	d	h	in l	W	D	H+Ha <sup>1</sup>	kW	in kg	to Tmax <sup>2</sup>
LT 3/11	1100	160	140	100	3	385	330	405+ 155	1,3	21	45
LT 5/11	1100	205	170	130	5	385	390	460+ 205	2,6	27	50
LT 9/11	1100	235	240	170	9	415	455	515+ 240	3,3	35	65
LT 15/11	1100	230	340	170	15	415	555	515+ 240	3,5	43	75
LT 24/11	1100	280	340	250	24	490	555	580+ 320	4,9	52	70
LT 40/11	1100	320	490	250	40	530	705	580+ 320	6,5	70	80
LT 60/11	1100	380	490	330	60	610	705	660+ 385	9,8	75	100
LT 3/12	1200	160	140	100	3	385	330	405+ 155	1,3	21	50
LT 5/12	1200	205	170	130	5	385	390	460+ 205	2,6	27	60
LT 9/12	1200	235	240	170	9	415	455	515+ 240	3,3	35	80
LT 15/12	1200	230	340	170	15	415	555	515+ 240	3,5	43	100
LT 24/12	1200	280	340	250	24	490	555	580+ 320	4,9	52	85
LT 40/12	1200	320	490	250	40	530	705	580+ 320	6,5	70	100

<sup>1</sup> including opened lift door

<sup>2</sup> If connected to 230 V 1/N/PE resp. 400 V 3/N/PE

### Muffle Furnaces with Brick Insulation and Flap Door or Lift Door

Model	Tmax	Inner dimensions in mm			Volume	Outer dimensions in mm			Connected load	Weight	Minuttt ia
		w	d	h		W	P	K+K a <sup>1</sup>			
L, LT 5/13	1300	225	170	130	5	490	450	580+320	2,6	46	53
L, LT 9/13	1300	250	240	170	9	530	525	630+350	3,3	58	59
L; LT 15/13	1300	250	340	170	15	530	625	630+350	3,5	71	76

<sup>1</sup> including opened lift door (LT models)

<sup>2</sup> If connected to 230 V 1/N/PE resp. 400 V 3/N/PE

### Muffle Furnaces with Fiber Insulation and Flap Door or Lift Door

Model	Tmax	Inner dimensions in mm			Volume	Outer dimensions in mm			Connected load	Weight	Minut es
		w	d	h		W	D	H+ Ha <sup>1</sup>			
L, LT 5/14	1400	225	175	130	5	490	450	580+320	2,6	42	44
L, LT 9/14	1400	250	250	170	9	530	525	630+350	3,5	55	51
L, LT 15/14	1400	250	350	170	15	530	625	630+350	3,5	63	68

<sup>1</sup> including opened lift door (LT models)

<sup>2</sup> If connected to 230 V 1/N/PE resp. 400 V 3/N/PE

### Compact Muffle Furnace

Model Flap door	Tmax	Inner dimensions in mm			Volume	Outer dimensions in mm			Connected load	Weight	Minutes
		w	d	h		W	D	H			
LE 1/11	1100	90	115	110	1	290	280	410	1,6	15	6
LE 2/11	1100	110	180	110	2	330	385	410	1,9	20	11
LE 6/11	1100	170	200	170	6	390	435	465	2,0	27	27

LE 14/11	1100	220	300	220	14	440	535	520	3,2	35	30
LE 24/11	1100	260	330	285	24	490	570	585	3,5	42	40

<sup>2</sup> If connected at 230 V 1/N/PE resp. 400 V 3/N/PE

### Ashing Furnaces

Model Flap door	Tmax	Inner dimensions in mm			Volume in l	Outer dimensions in mm			Connected load kW	Weight in kg	Minutes to Tmax <sup>2</sup>
		w	d	h		W	D	Hb <sup>1</sup>			
LV 3/11	1100	180	160	120	3	343	392	810	1,2	20	120
LV 5/11	1100	200	170	130	5	382	416	810	2,4	35	120
LV 9/11	1100	230	240	170	9	412	485	865	3,0	45	120
LV 15/11	1100	230	340	170	15	412	585	865	3,5	55	120

<sup>1</sup> Including exhaust tube (Ø 80 mm)

<sup>2</sup> If connected at 230 V 1/N/PE resp. 400 V 3/N/PE

### Ashing Furnaces

Model Lift Door	Tmax	Inner dimensions in mm			Volume in l	Outer dimensions in mm			Connecte d load kW	Weight in kg	Minutes to Tmax <sup>2</sup>
		w	d	h		W	D	Hb <sup>1</sup>			
LVT 3/11	1100	180	160	120	3	343	392	810	1,2	20	120
LVT 5/11	1100	200	170	130	5	382	416	810	2,4	35	120
LVT 9/11	1100	230	240	170	9	412	485	865	3,0	45	120
LVT 15/11	1100	230	340	170	15	412	585	865	3,5	55	120

<sup>1</sup> Including exhaust tube (Ø 80 mm)

<sup>2</sup> If connected at 230 V 1/N/PE resp. 400 V 3/N/PE

Model	LV(T) 3/11	LV(T) 5/11	LV(T) 9/11	LV(T) 15/11
Organic material <sup>1</sup>	5 g	10 g	15 g	25 g
Max. evaporation rate <sup>2</sup>	0,2 g/min	0,3 g/min	1,1 g/min	1,2 g/min

<sup>1</sup> Quantity per charge

<sup>2</sup> Amount of carbon in the product

The composition of the binder, the quantity of organics, the product geometry and the duration of the vaporization phase determine the dynamic of the vaporization. These parameters must be configured in such a way that the limit values are not exceeded.




**Warning – Danger of explosion**

The quantity of organic material and the temperature curve must be defined so that the maximum rate of evaporation and quantity of organic material are not exceeded.

**Muffle Furnace**

Model Flap Door/ Lift Door	Tmax	Inner dimensions in mm			Volu me	Outer dimensions in mm			Connected load	Weight	Minu tes
		°C	w	d		h	in l	W			
L 9/11/SKM	1100	230	240	170	9	490	505	580	3,4	50	90
LT 9/11/SKM	1100	230	240	170	9	490	505	580+ 320	3,4	50	90

<sup>1</sup> Including opened lift door

<sup>2</sup> If connected at 230 V 1/N/PE resp. 400 V 3/N/PE

**Muffle Furnace**

Model Flap Door/	Tmax	Inner dimensions in mm			Volu me	Outer dimensions in mm			Connected load	Weight	Minutes
		°C	w	d		h	in l	W			
L 9/11/SW	1100	230	240	170	9	415	455	740	3,0	50	75
L 9/12/SW	1200	230	240	170	9	415	455	740	3,0	50	90

<sup>2</sup> If connected at 230 V 1/N/PE resp. 400 V 3/N/PE

**Muffle Furnace**

Model Lift Door/	Tmax	Inner dimensions in mm			Volu me	Outer dimensions in mm			Connected load	Weight	Minutes
		°C	w	d		h	in l	W			
LT 9/11/SW	1100	230	240	170	9	415	455	740+ 240	3,0	50	75
LT 9/12/SW	1200	230	240	170	9	415	455	740+ 240	3,0	50	90

<sup>1</sup> incl. opened lift door

<sup>2</sup> If connected at 230 V 1/N/PE resp. 400 V 3/N/PE

### Scale

Type	Readability	Weight Range	Stamp Weight	Calibration Value	Minimum Load
	in g	in g	in g	in g	in g
EW-2200	0.01	2200 incl. plunger	850	0.1	0.5
EW-4200	0.01	4200 incl. plunger	850	0.1	0.5
EW-6200	0.01	6200 incl. plunger	850	-	1.0
EW-12000	0.10	12000 incl. plunger	850	1.0	5.0

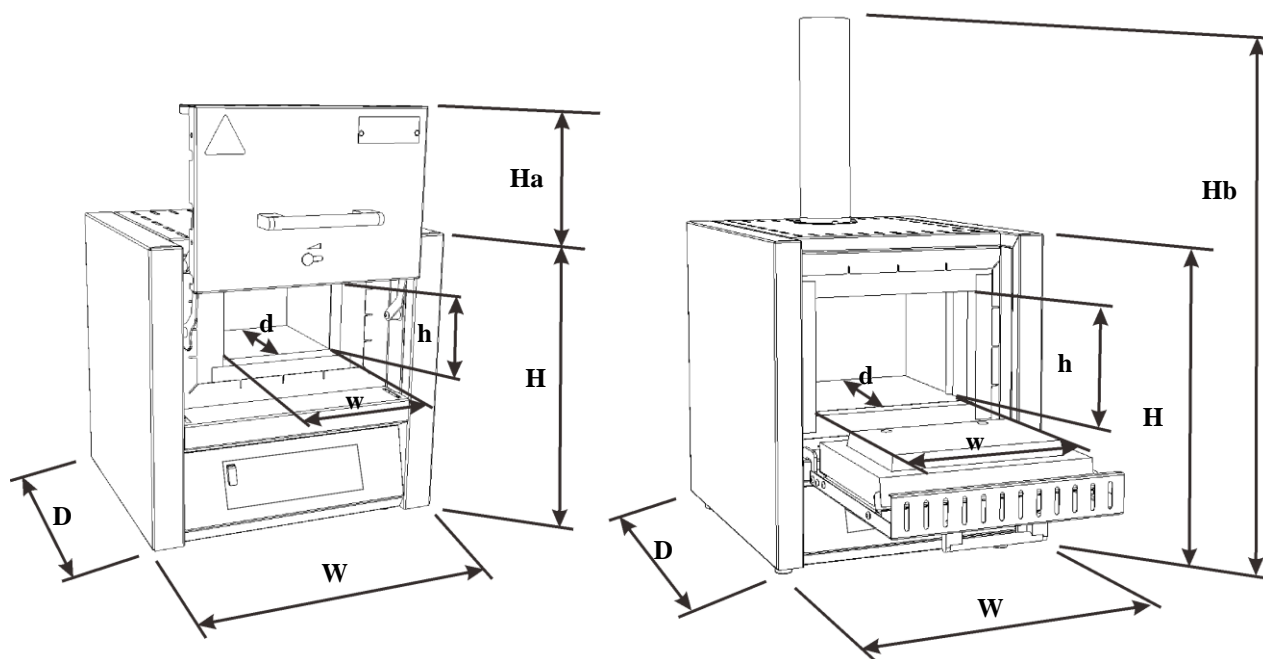


Fig. 15: Dimensions

Electrical connection		1-phase: (1/N/PE) 2-phase: (2/N/PE)	3-phase: (3/N/PE)
	Model:	to 3.6 kW	from 4.5 kW
	Power plug	Safety plug (with snap-in socket)	CEE plug
	Voltage:	110 V – 240 V	380 V – 480 V
	Frequency:	50 or 60 Hz	
	Heating power in kW:	See “Specifications” or the type plate on the furnace	
Thermal protection class	Furnace:	according to DIN EN IEC 60519-1	
Protection type	Furnace	IP20	
Ambient conditions for electrical equipment	Temperature: Humidity:	+5 °C to + 40 °C max. 80% non-condensing	
Emissions	Continuous sound pressure level	< 70 dB(A)	

Model	Connected load of accessories	Max. connected load of accessories
L 1/12	220 – 240 V	460 W
L(T) 3/11	220 – 240 V	460 W
L(T) 3/12	220 – 240 V	460 W
L(T) 5/11	220 – 240 V	460 W
L(T) 5/12	220 – 240 V	460 W
L(T) 9/11	220 – 240 V	460 W
L(T) 9/12	220 – 240 V	460 W
L(T) 15/11	220 – 240 V	100 W
L(T) 15/12	220 – 240 V	100 W
L(T) 24/11	220 – 240 V	460 W
L(T) 24/12	220 – 240 V	460 W
L(T) 40/11	220 – 240 V	460 W
L(T) 40/12	220 – 240 V	460 W
LT 60/11	220 – 240 V	460 W
LT 60/12	220 – 240 V	460 W

### 3 Warranty and Liability



**As regards warranty and liability, the normal Nabertherm warranty terms apply, unless individual terms and conditions have been agreed. However, the following conditions also apply:**

Warranty and liability claims for personal injury or damage to property shall be excluded if they are attributable to one or more of the following causes:

- All persons involved in operation, installation, maintenance, or repair of the furnace must have read and understood the operating instructions. No liability will be accepted for damage or disruption to operation resulting from non-compliance with the operating instructions.
- Not using the furnace as intended
- Improper installation, start-up, operation, or maintenance of the furnace,
- Operation of the furnace with defective safety equipment or improperly installed or non-functioning safety and protective equipment
- Not observing the information in the operating instructions with respect to transportation, storage, installation, start-up, operation, maintenance, or equipping the furnace
- Making unauthorized changes to the furnace
- Making unauthorized changes to the operating parameters
- Making unauthorized changes to the parameterization, the settings, or the program
- Nabertherm accepts absolutely no liability for damage caused by using parts that are not original Nabertherm parts. Original parts and accessories are designed especially

for Nabertherm furnaces. Replace parts only with original Nabertherm parts. Otherwise the warranty will be void.

- Catastrophes due to third-party causes and force majeure

## 4 Safety

### 4.1 Defined Application



The Nabertherm furnace was designed and built in conformance with a careful selection of the applicable harmonized standards and other technical specifications. Hence, it corresponds to the state of the art and assures the greatest degree of safety.

- The laboratory furnaces are suitable for general use in the fields of materials research and heat treatment. Furnaces in the LV series are designed especially for ashing laboratory samples.
- Furnaces in this series can be used to burn out dental wax. When using, observe the wax manufacturer's safety data sheets.



#### **For all furnace systems**

Operation with explosive gases or mixtures or explosive gases or mixtures formed during the process is prohibited.

#### **Improper furnace operation:**

- The furnace must **not** be used for heating food.
- Any other use, such as processing of products other than those for which the furnace was intended as well as handling hazardous materials or materials dangerous to health is deemed IMPROPER.
- Under certain circumstances gases or materials may be released from the materials in the furnaces that settle on the insulation or the heating elements and destroy them. **If applicable, read the labels and instructions on the packaging of materials that you use.**
- The introduction of solvent-containing components and coatings, or components with very high water content
- The use of substances that are transformed into compounds harmful to health as a result of thermal decomposition. If this cannot be ruled out, the operator must take special measures, such as precautions at the installation site, protective equipment for the operator, measures to reduce exhaust emissions.
- Furnaces with over-temperature limit controllers must have their shut-down temperatures set to prevent any overheating of the material.
- The set-up instructions and safety regulations must be followed, otherwise the furnace will be considered improperly used, effectively cancelling any claims against Nabertherm GmbH. The EC Declaration of Conformity will cease to be valid if any modifications are made to the machine without our approval.
- The set-up instructions and safety regulations must be followed, otherwise the furnace will be considered improperly used, effectively cancelling any claims against Nabertherm GmbH.
- Opening the furnace while it is still hot, over 200 °C (392 °F), can lead to increased wear of the following components: insulation, door seal, heating elements and furnace

housing. No liability shall be accepted for any damage to the goods or the furnace resulting from non-compliance with this warning.



Operation with power sources, products, operating equipment, auxiliary materials, etc., which are listed as hazardous or which may in any way harm the health of the operator is prohibited.

The furnace must not be filled with materials or substances that release explosive gases or vapors. Only materials and substances whose properties are known may be used.

**Note**

Continuous operation at maximum temperature can lead to increased wear of heating elements, insulation materials and metallic components. We recommend working at approx. **50 °C below maximum temperature**.

**Note**

Depending on use, wearing parts, such as heating elements and insulation material, can be subject to increased wear. High temperatures on the stainless steel (especially if the furnace is opened when hot) can cause discoloration; however, this in no way affects the function of the furnace.

- This furnace is designed for **commercial** use. The furnace may **not** be used for warming animals, solvents, etc.
- The furnace may not be used to heat the workplace
- Do not use the furnace to melt ice or similar materials.
- Do not use the furnace as a clothes dryer.

**Note**

Applicable safety instructions are contained in the individual sections.



**Note**

**This product does not comply with the ATEX Directive and may not be used in ignitable atmospheres. The system must not be operated with explosive gases or mixtures and it must be ensured that explosive gases or mixtures do not form during the process.**

**Note**

If the device is not used in accordance with the operating instructions, the intended level of protection may be impaired.

## 4.2 Safety Concept for Furnace Model LV(T) ../.

**Furnace model LV(T) ../.:** These furnace models were designed to determine loss on ignition.

### Warning – Danger of explosion

**The quantity of organic material and the temperature curve must be defined so that the maximum rate of evaporation and quantity of organic material are not exceeded.**

The quantity of organic material, the product geometry and the duration of the evaporation phase are important for the dynamics of evaporation. These parameters must be designed so that limit values are not exceeded.

The limit values are:

- 20 % of the lower explosion limit (LEL)
- Maximum setting weight of organic material in g (see “Technical Data”)
- Maximum evaporation rate in g/min (see “Technical data”)
- The operator is responsible for compliance with the limit values. The controls do not actively monitor these limit values. Where appropriate, compliance must be demonstrated through appropriate measurement. Changes to the process parameters require a new theoretical or metrological check.

The main parameter to adapt processes is the heating rate. The evaporation dynamics of the product are not linear. Therefore, it may be necessary to slow down the rate of heating in certain parts of the debinding/ashing process to comply with the intended limit values.

- Only substances and materials that decompose to gaseous hydrocarbons may be processed. Other risks, such as health risks due to gaseous concentrations, are not covered by the concept. The operator must assess the risks for the workplace and the environment.
- Materials and substances that emit heat as the result of a reaction should be avoided. The limit value for the evaporation rate may be exceeded through an uncontrolled rise in temperature.
- Legal and structural requirements for exhaust gas routing inside and outside the building must be checked by the operator. Laws and local regulations may require a suitable exhaust gas treatment system.



**Note**

The furnace must not be operated with explosive gases or mixtures or with explosive gases or mixtures that form during the process.

The concentration of organic gas mixtures may never exceed 20 % of the lower explosion limit (LEL) in the furnace. This requirement not only applies to normal operation, but also in particular to exceptional circumstances, such as process malfunctions (due to the breakdown of a unit, etc.). Ensure sufficient ventilation of the furnace.



**Note**

**This product does not comply with the ATEX Directive and may not be used in ignitable atmospheres. The system must not be operated with explosive gases or mixtures and it must be ensured that explosive gases or mixtures do not form during the process.**

### 4.3 Requirements for the Furnace Operator



The set-up instructions and safety regulations must be followed, otherwise the furnace will be deemed to have been used improperly, effectively cancelling any claims against Nabertherm GmbH.

This level of safety when operating the furnace can be achieved only if all the necessary measures have been taken. It depends on the furnace operator's diligence in planning these measures and controlling how they are carried out.

#### The Operator must ensure that

- all harmful gases are removed from the workplace, for example by an extraction system,
- the extraction system is switched on,
- the workplace is properly ventilated,
- the furnace is operated only in a perfect operating condition and, in particular, that the functions of the safety components are checked regularly.
- the required personal protective equipment is available for and used by the operating, maintenance, and repair personnel.
- these operating instructions, including the supplier documentation, are kept near the furnace. These instructions must be available at all times for anyone working with or on the furnace;
- all the safety and operating instruction signs on the furnace can be read properly. Damaged or unreadable signs must be replaced immediately,
- furnace personnel are informed regularly about all issues involving occupational safety and environmental protection and are familiar with all the operating instructions, especially those involving safety,
- a risk assessment is carried out (in Germany, covered of the Occupational Safety Act) to determine any other hazards that may result from the working conditions particular to the furnace's location,
- all other instructions and safety guidelines that have been determined in a risk assessment for the workplace are compiled in an operation manual (in Germany, covered of the Ordinance Regulating the Use of Operating Equipment).
- Only sufficiently qualified and authorized personnel may operate, maintain and repair the system. This personnel must be trained in how to operate the furnace and must confirm their participation in the training with a personal signature. The training program must be documented in detail. In case an operator is replaced, additional training must also take place. The additional training may only be performed by authorized, trained individuals familiar with the system. The additional training must be painstakingly documented and participation must be evidenced by the names and signatures of the participating employees.



#### Note

In Germany, the general accident protection guidelines must be observed. The accident prevention regulations applicable in the country where the furnace is installed must be observed.

### 4.4 Requirements for the Operating Personnel



All persons involved in operation, installation, maintenance, or repair of the furnace must have read and understood the operating instructions. No liability will be accepted for damage or disruptions to operation resulting from non-compliance with the operating instructions.

Only adequately qualified and authorized persons may operate, maintain, and repair the

system.

These personnel are informed regularly about all issues involving occupational safety and environmental protection and are familiar with all the operating instructions, especially those involving safety,

Only trained personnel may operate the control and safety equipment.

## 4.5 Protective Clothing



Wear protective clothing



Wear heat-resistant gloves to protect your hands.



Wear goggles to protect your eyes.

## 4.6 Basic Measures During Normal Operation



### **Risks during Normal Operation!**

Before switching the furnace on, check and ensure that only authorized persons are in the working area of the furnace and that no one can be injured as a result of operating the furnace.

Before starting production each time, check and ensure that all the safety equipment works properly.

Before starting production each time, check the furnace for obvious damage and ensure that it is operated only in a perfect condition. Report any defects to a supervisor immediately.

Before starting production each time, remove all materials and objects that are not needed for production from the working area.

**At Least once every Day (see also Servicing and Maintenance) Check the Following:**

- Check the furnace for obvious external damage,
- Check all hydraulic or pneumatic hoses, make sure that they are not leaking and that they are connected properly (if applicable),
- Check all gas and oil lines, make sure that they are not leaking and that they are connected properly (if applicable),
- Check that the fan works properly (if applicable)



## 4.7 Basic Measures in Case of Emergency

### 4.7.1 What to Do in an Emergency



**Note**

The power plug is to be pulled out to stop the furnace in case of an emergency. Therefore, the power plug must be accessible at all times when the furnace is operating so that it can be pulled out quickly in case of an emergency.

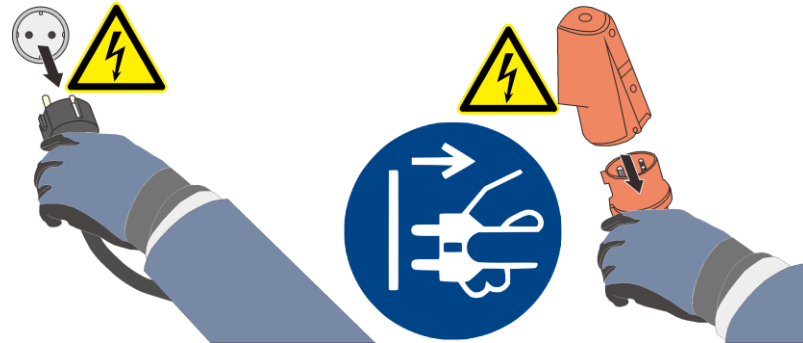


Fig. 16: Pull the power plug (similar to picture)



**Risks during Normal Operation!**

Switch the furnace off immediately in case of unexpected occurrences in the furnace (e.g. a lot of smoke or unusual smells). Wait until the furnace has cooled naturally to room temperature.

<b>DANGER</b>		
A yellow triangle with a black border containing a black silhouette of a person slipping.	<ul style="list-style-type: none"> <li>• <b>Danger of electric shock.</b></li> <li>• <b>Risk of fatal injury.</b></li> <li>• Work on electrical equipment may be carried out only by qualified electricians or by trained personnel authorized by Nabertherm.</li> <li>• Before starting work, pull out the power plug</li> </ul>	A blue circle containing a white icon of a power plug with an arrow pointing to the right.

## 4.8 Basic Measures for Servicing and Maintenance



Maintenance work must be performed only by authorized persons, observing the maintenance instructions and the accident prevention regulations. We recommend that maintenance and repair work be carried out by the service team of Nabertherm GmbH. Non-compliance may cause injuries, death, or considerable damage to property.

Switch off the system and make sure it cannot be switched on again inadvertently (lock the main switch and secure it with a padlock), or pull out the power plug.

Clear an adequate area around the system to facilitate the repair work.

Suspended loads are dangerous. Working beneath a suspended load is prohibited. There is a risk of fatal injury.

Relieve the pressure on hydraulic and pneumatic equipment before carrying out maintenance or repair work. (if applicable).

When cleaning furnaces, control cabinets, or electrical equipment housings, never spray them with water.

When maintenance or repair work has been completed, before recommencing production ensure the following:

- Check that loosened screw connections have been re-tightened,
- Reinstall protective equipment, screens, and filters,
- Remove all material, tools, and other equipment used for the maintenance or repair work from the working area of the system,
- Remove any liquids that have leaked,
- Check that all safety functions (e.g. EMERGENCY STOP button) work properly,
- Power cables may be replaced only with similar, approved cables

Repairs to the insulation or the replacement of components in the heating chamber may only be performed by persons who are trained about possible hazards and protective measures and can apply this knowledge without supervision.

## 4.9 Environmental Regulations

All statutory duties regarding waste avoidance, proper recycling, and disposal must be observed when work is carried out on and with the furnace.

Problem materials that are no longer needed, such as lubricants or batteries, must not be placed in normal waste disposal systems or allowed to enter the sewage system.

During installation, repair, and maintenance work, substances that are hazardous to water, such as

- lubricating grease and oils
- hydraulic oils
- refrigerants
- solvent-based cleaning fluids must not be allowed to contaminate the soil or enter the sewage system.

These substances must be stored, transported, collected, and disposed of in suitable containers.



### Note

The operator must ensure that national environmental regulations are observed.

When it is delivered, this furnace contains no substances that make a hazardous waste classification necessary. However, residues of process materials may accumulate in the furnace insulation during operation. These may be hazardous to health and/or the environment.

- Dismantle the electronic components and dispose of them as electric scrap.
- Remove the insulation and dispose of it as hazardous waste (see “Servicing, Cleaning, and Maintenance with Ceramic Fiber Material”).
- Dispose of the housing as scrap metal.
- Contact the responsible disposal company to dispose of the materials listed above.

## 4.10 General Risks with the Furnace



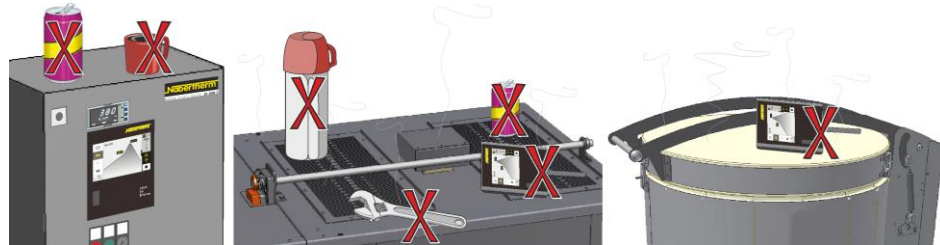
### Warning – General Hazards!

- Risk of burning on the furnace housing and on the tube
- The door handle/grip can become very hot during operation; wear gloves.
- Risk of crushing on moving parts (door hinge, rotary tube drive, lifting table, etc.)
- The switchgear cabinet (if present) and the terminal boxes on the system contain dangerous electrical voltages.
- Do not insert any objects into the openings on the furnace housing, exhaust air holes, or cooling slots on the switchgear or furnace (if present). This poses a risk of electric shock.



### Warning – General Hazards

No objects may be placed or set down on the furnace or switchgear. There is a risk of fire or explosion.



<b>⚠ DANGER</b>		
	<ul style="list-style-type: none"> <li>• <b>Danger from electrocution</b></li> <li>• <b>If there is no earth connection, or the earth connection is poorly connected, the result may be a deadly electrical shock.</b></li> <li>• Do not insert any metallic objects such as thermocouples, sensors or tools into the furnace chamber without having previously ensured that the plant has been correctly earthed. Entrust the job of making a earth connection between the object and the furnace housing to a qualified electrical technician. Any objects inserted into the furnace must be inserted only through those openings intended for this purpose.</li> </ul>	

## 5 Transportation, Installation and Initial Start-Up

### 5.1 Delivery

#### Check that Everything is Complete

Compare the delivered items with the delivery note and the purchase order documents.

**Immediately** notify the carrier and Nabertherm GmbH of any missing or damaged parts, as complaints at a later date cannot be acknowledged.

#### Danger of Injury

When the furnace is being lifted, parts of the furnace or the furnace itself could topple over, slip, or fall. Before the furnace is lifted, make sure no one is in the working area. Wear safety footwear and a hard hat.

#### Safety Instructions

- Forklifts must be operated only by authorized personnel. The operator bears sole responsibility for safe operation and the load
- When the furnace is being lifted, make sure that the ends of the forks or the load do not catch on neighboring goods. Use a crane to move tall parts, such as control cabinets.
- Use only lifting equipment with sufficient load-bearing capacity
- Lifting gear must be attached only to positions that have been designated for this purpose
- Attachments, piping, or cable conduits must never be used to affix lifting gear
- Unpackaged parts should only be lifted with ropes or straps
- Attach transportation equipment only to positions intended for this purpose.
- Lifting and securing equipment must conform to the provisions contained in accident prevention regulations
- Consider the weight of the furnace when choosing lifting and securing equipment. (see Specifications)
- Stainless steel parts (including mounting elements) must always be kept separate from unalloyed steel parts
- Do not remove corrosion protection until immediately prior to assembly



#### Risks during Normal Operation!

Suspended loads are dangerous. Working beneath a suspended load is prohibited. There is a risk of fatal injury.



#### Note

Safety and accident prevention guidelines applicable for forklift trucks must be followed.

#### Transportation with a Pallet Truck

Observe the maximum permitted capacity of the pallet truck.

1. Our furnaces are delivered ex works on wooden frames to facilitate unloading. Transport the furnace in its original packaging and with suitable equipment to prevent any damage. Remove the packaging only when the furnace is in its final location. When transporting the furnace, make sure it is secured against sliding, toppling over, and damage. The furnace should be transported and installed by at least two persons. **Do not store the furnace in damp rooms or outdoors.**
2. Push the pallet truck underneath the transportation frame. Make sure that the pallet

truck is **completely** beneath the frame. Pay attention to neighboring goods.

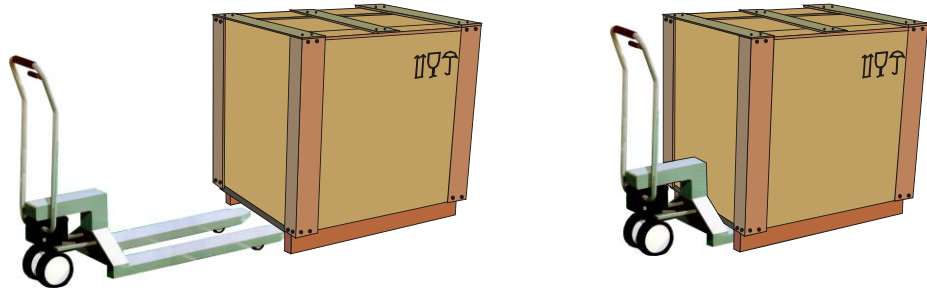








Fig. 17: Pallet truck is pushed **completely** beneath the transportation frame


3. Lift the furnace carefully and pay attention to its center of gravity. When the furnace is being lifted, make sure that the ends of the forks or the load do not catch on neighboring goods.
4. Make sure that the furnace is balanced safely; if not, attach securing equipment. Push the furnace carefully, slowly and with the pallet truck at its lowest position. Do not transport the furnace on inclines.
5. Carefully lower the furnace at its final position. Pay attention to neighboring goods. Try not to set it down too abruptly.

	 <b>CAUTION</b>	
	<ul style="list-style-type: none"> <li>• <b>Device may slip or topple over.</b></li> <li>• <b>Damage to the device.</b></li> <li>• Risk of injury from lifting heavy loads.</li> <li>• Transport device only in original packaging.</li> <li>• Several people must carry the device.</li> </ul>	

### Symbols:

The symbols for handling packaging are defined in ISO R/780 (International Organization for Standardization) and in DIN 55402 (German Institute for Standardization).

Description	Symbol	Explanation
Fragile		This symbol is to be attached to fragile goods. Goods marked like this are to be handled carefully and must not be thrown or tied up.
This side up		The freight must be transported, transshipped, and stored in such a way that the arrows point upward. The freight must not be rolled, folded, or stored on edge. However, the package does not have to be packed on top of other freight.
Keep dry		Products with this symbol must be protected against high air moisture, hence, they must be stored under cover. If particularly heavy or bulky packages cannot be stored in halls or sheds, they must be covered carefully with a tarpaulin or similar.

Description	Symbol	Explanation
Sling here		The symbol shows only where the sling should be attached, not the method of slinging. If the symbols are at an equal distance from the middle or center of gravity of the package, the package hangs straight if the slings are the same length. If this is not the case, the sling on one side has to be shortened.

## 5.2 Unpacking



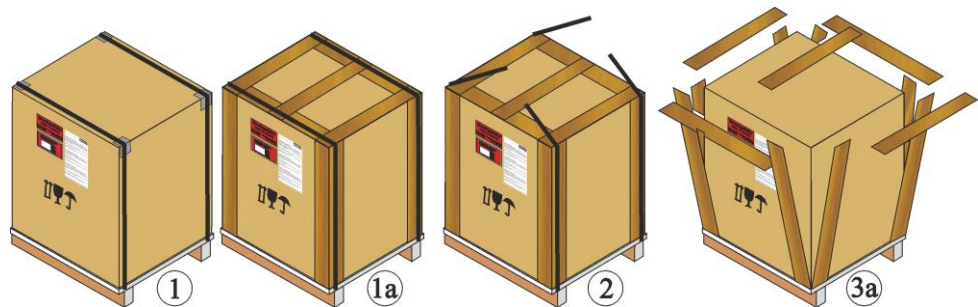
### Note

The furnace packaging prevents damage during transportation. Make sure that you remove all packaging material (also inside the Furnace Chamber). Keep the packaging and transportation securing equipment in case it is needed for future transportation or storage.

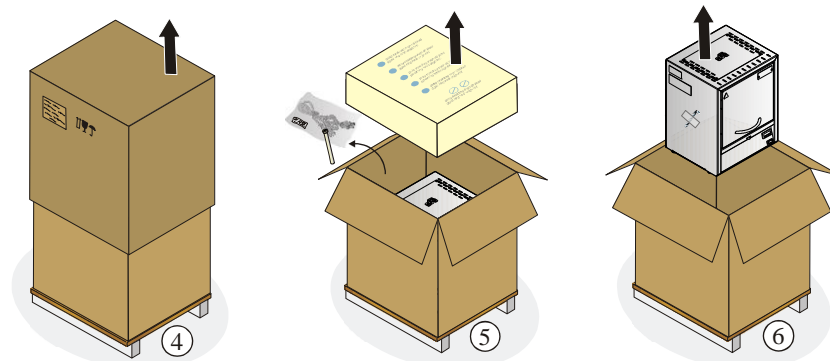
At least two people are needed to carry/transport the furnace, more for larger furnaces.



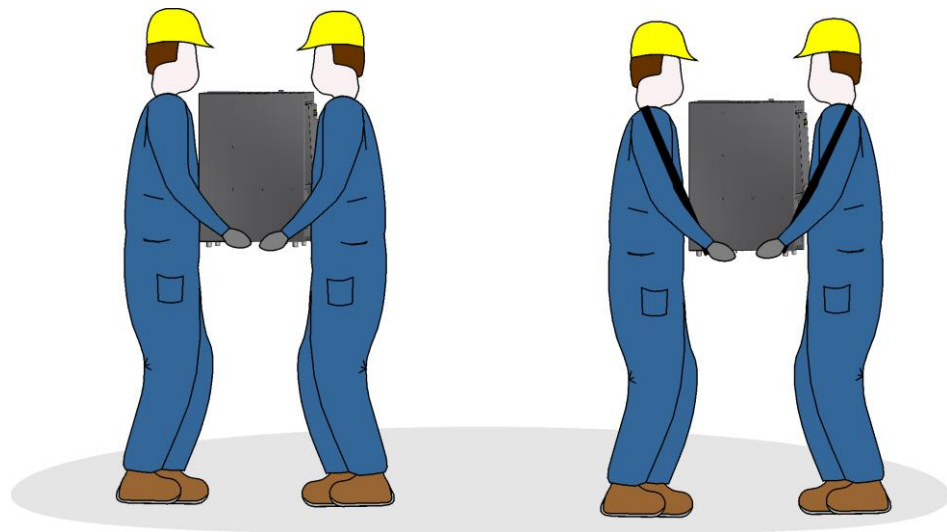
Wear protective gloves



1. Check the transportation packaging for possible damage.
2. Remove tensioning straps from the transportation packaging.
3. Slacken screws and remove wooden casing from the covering box (if available 3a).



4. Carefully lift the cardboard box and remove it from the pallet.
5. Remove the foam insert in the box. The box contains a packaging unit for accessories (Example: exhaust air tube, insert plate, power cable). Compare the delivered items with the delivery note and the order documents, see "Delivery".
6. Carefully lift the furnace out of the packaging unit.



7. To carry, grip furnace from below at the sides and make sure you have a firm grip.
8. For furnaces weighing more than 25 kg, transport work must be carried out by at least 2 people. If transport straps are used, they must be attached crosswise only. Ensure that they are secure.



**Note**

In Germany, the general accident protection guidelines of VBG or BGZ must be observed. The national accident prevention regulations of the country of operation apply.



**Note**

Save the packaging for possible shipping or for storing the furnace.

### 5.3 Transport Securing Device/Packaging



**Note**

**No special** transportation securing equipment is available for this furnace

The furnace packaging prevents damage during transportation. Make sure that you remove all packaging material (also inside the Furnace Chamber). All packaging material can be recycled. The packaging was designed so that no special description is necessary.

## 5.4 Constructional and Connection Requirements

### 5.4.1 Installation (Furnace Location)

When setting up the furnace, these safety instructions must be followed:

- The furnace must be installed in a dry room in accordance with the safety instructions.
- The table/supporting surface must be flat to enable the furnace to be installed straight. Place the furnace on a **non-flammable** surface (fire safety class A DIN 4102 – Example: concrete, tiles, glass, aluminum or steel) so that any hot material falling from the furnace cannot ignite the surface.
- The carrying capacity of the table must be designed to bear the weight of the furnace incl. accessories.

- The floor covering must be made of non-flammable material so that hot material falling out of the furnace will not cause the floor covering to ignite.

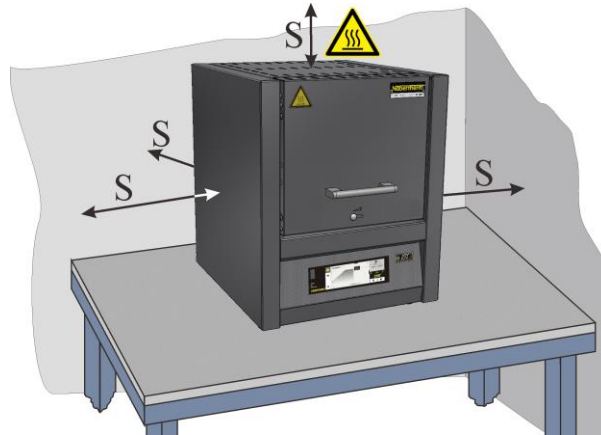




Fig. 18: Minimum safety distance to flammable materials (Table-top model) (similar to picture)

### Installation Location

- The operator is responsible for adequate ventilation by installing the appropriate systems to supply fresh air and to vent exhaust air. If a batch emits gases or vapors, adequate ventilation of the installation site must be provided as well as a suitable exhaust air venting system. A suitable vent for combustion exhaust must be supplied by the customer
- Make sure that the heat radiated by the furnace is vented (consult a ventilation expert, if necessary)
- Although the furnace is well-insulated, the exterior surfaces of the furnace radiate heat. If necessary, this heat must be dissipated (**a ventilation technician may need to be consulted**). In addition, a minimum clearance (**S**) of 0.5 m on all sides and 1 m above the furnace must be maintained to flammable materials. In individual cases, more space must be chosen in order to match the local conditions. For **nonflammable materials**, the minimum **side** clearance can be reduced to 0.2 m.
- The furnace must be protected against weather and caustic atmospheres. Nabertherm accepts no liability or warranty claim for any corrosion damage as a result of installation in damp surroundings or for similar reasons.



	 <b>DANGER</b>
	<ul style="list-style-type: none"> <li>• <b>Risk of fire, danger to health</b></li> <li>• <b>Risk of fatal injury</b></li> <li>• Adequate ventilation must be ensured at the installation location to remove exhaust heat and exhaust gases</li> </ul>



### Note

Before starting the furnace for the first time, allow it to acclimatize at its installation location for 24 hours.



	 <b>DANGER</b>
	<ul style="list-style-type: none"> <li>• <b>Danger associated with the use of an automatic extinguishing system</b></li> <li>• <b>Danger to life from electrocution through wetness, suffocation caused by extinguishing gas, etc.</b></li> <li>• If automatic extinguishing systems are in place to fight fires and protect the building, e.g. sprinkler systems, care must be taken during their planning and installation that no additional hazards are created, for example by extinguishing a pilot light, mixing hardening oil and extinguishing water, shutdown of electrical equipment, etc.</li> </ul>

## 5.5 Assembly, Installation, and Connection

### 5.5.1 Connecting the Furnace to the Power Supply

On the building side, the required services must be provided, i.e. the carrying capacity of the installation surface, provision of power (electricity), etc.

- The furnace must be installed in accordance with its intended use. The power connection values must correspond to the values on the furnace type plate.
- The power socket must be located close to the furnace and must be easily accessible. The safety requirements are not met if the furnace is not connected to a socket with grounding contact.
- On use of an extension cable or a multipoint socket, the maximum electrical rating must not be exceeded. Do not use the furnace with an extension cable if you are uncertain whether grounding is guaranteed.
- The power cable must not be damaged. Do not place any objects on the power cable. Route the cable so that nobody can tread on or stumble over it.
- A damaged power cable must be replaced immediately.
- Ensure that the furnace's connection cable is routed so that it is protected.



#### Note

Before connecting the power, make sure that the power switch is set to "Off" or "0".

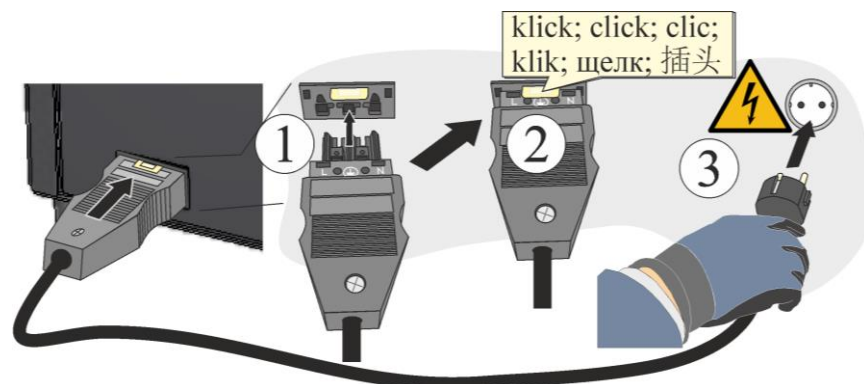


Fig. 19: Depending on model – supplied power cable included in scope of delivery (illustration similar)

1. Plug the supplied connection cable with snap-in coupling into the rear wall of the furnace.
2. Then connect the power cable to the power supply. Use only a grounded socket.

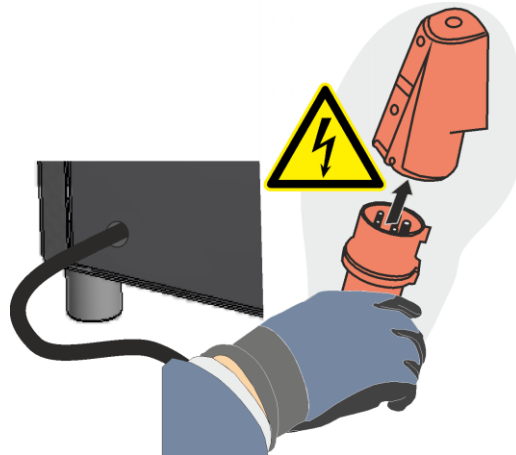


Fig. 20: Depending on model – CEE plug (illustration similar)

1. Connect the power cable to the power supply. Use only a grounded socket. Check the ground resistance (acc. to VDE 0100); see also accident prevention regulations.  
Electrical systems and equipment according to DGUV V3.





**Note**


The national regulations of the respective country of operation apply.



**Warning – Danger of Electric Shock!**

Work on the electrical equipment may be done only by qualified, authorized electricians.

	<b>CAUTION</b>	
	<ul style="list-style-type: none"> <li>• <b>Danger from incorrect voltage</b></li> <li>• <b>Damage to the device</b></li> <li>• Check voltage before connecting and starting the furnace</li> <li>• Compare the voltage with the details on the type plate</li> </ul>	

	<b>⚠ DANGER</b>
	<ul style="list-style-type: none"> <li>• <b>Risk of fire, danger to health</b></li> <li>• <b>Risk of fatal injury</b></li> <li>• Adequate ventilation must be ensured at the installation location to remove exhaust heat and exhaust gases</li> </ul>

## 5.5.2 Assembly of a Vent

Which vents are supplied vary depending on the application/order (does not apply to protective gas connection):

### Vent (not for LV Models)

- Vent which exhausts the escaping gases and vapors through the exhaust air connecting piece and releases them overhead. Exhaust air cross section: 40 x 30 mm
- Install by slipping the vent onto the connecting piece on the back wall of the furnace and fasten it with the screws included in the scope of delivery.

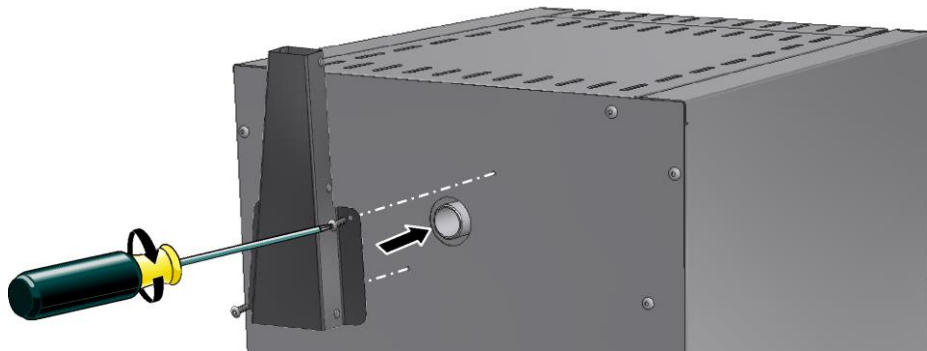


Fig. 21: Vent (similar to picture)

### Vent with fan (not for LV Models)

- Supports the venting of gases and vapors from the furnace chamber. Exhaust air cross section: Ø 80 mm
- Install by slipping the vent onto the connecting piece on the back wall of the furnace and fasten it with the screws included in the scope of delivery. Plug the connecting plug into the socket on the back of the switchgear (optional) or in an external socket.

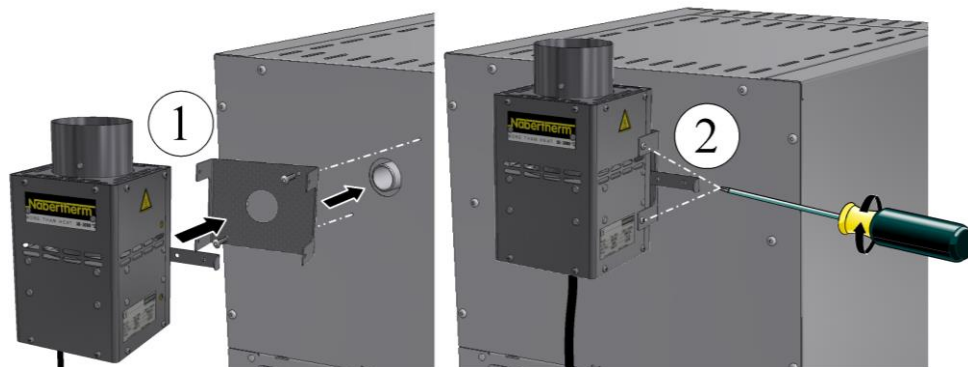


Fig. 22: Vent with fan (similar to picture)

### Vent with Fan and Catalytic Converter (not for LV Models)

- Heats the gases and vapors from the furnace chamber to approx. 600 °C and feeds it through the catalytic converter honeycomb. The converter incinerates most of the organic substances, i.e. breaks them down into carbon dioxide and steam. This largely eliminates any annoying odors (for example, during dewaxing).
- Warning! Inorganic substances such as heavy metals halogens, silicons and particulates (even in small quantities) will destroy the catalytic converter!
- The temperature of the catalytic converter must be checked; from the start of the program the converter must be operating at approx. 600 °C. A statement cannot be

made regarding residues which may be released into the environment. This is largely dependent on the individual materials/embedding masses used and their compositions.  
 Exhaust air cross section: 120 x 120 mm

- Installation: Fasten the U-shaped brackets to the back wall of the furnace using the screws included in the scope of delivery, slide the included section of pipe onto the connecting piece of the furnace and screw the vent (with CAT) firmly to the bracket. Plug the power plug into the socket on the back side (optional) of the switchgear or into an external socket.

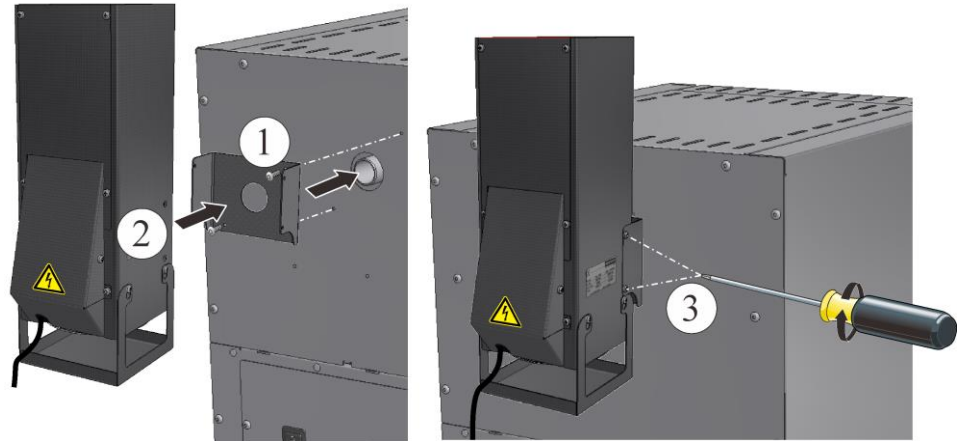


Fig. 23: Catalytic converter (similar to picture)

#### Installation of an Exhaust Gas Pipe on LV(T) .../... Models

- These models come with a special exhaust gas pipe.
- Begin the installation by fastening the rectangular pipe to the inner housing of the furnace with the screws included in the scope of delivery, then by fastening the rounds section to the outer housing. The screws included in the scope of delivery are for this purpose.
- Operating the furnace without this pipe results in a reduced air flow which is insufficient for an incinerating process.

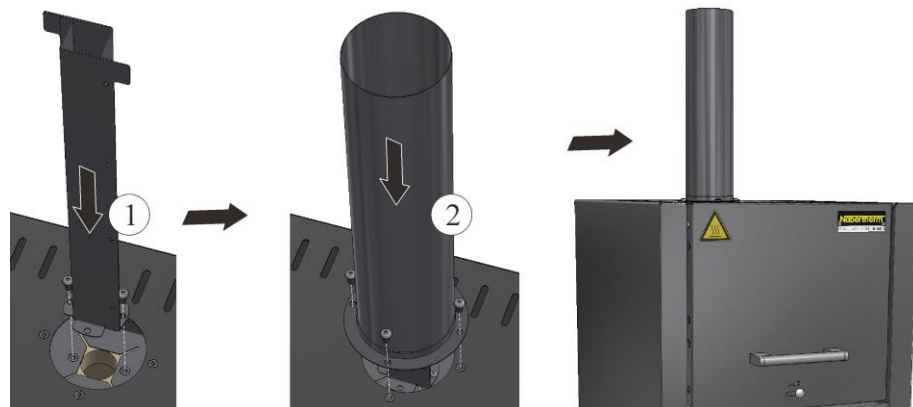


Fig. 24: Installation of an exhaust gas pipe on LV(T) models (similar to picture)



#### Caution

The installation of a catalytic converter or vent with fan is not possible on these models.

### 5.5.3 Venting Exhaust Fumes

We recommend connecting an exhaust air pipe to the furnace to remove the exhaust gases. For this purpose you can use a commercially available, metal exhaust gas pipe with NW 80 to NW 120. It must be installed continuously rising and fastened to the wall or ceiling. Center the pipe over the furnace vent (for models with vent fan or catalytic converter, NW 120 is necessary).

The exhaust gas pipe must not be installed with a tight fit to the furnace vent pipe since this would prevent any bypass effect. This is necessary so that not too much fresh air is sucked in by the furnace. (An exception are the LV furnaces: Here the exhaust gas pipe NW 80 can be slid directly onto the furnace vent pipe.)

**Exhaust air (model LV/LVT) or vent with fan (A):** Position the exhaust air piping approx. 50 mm over the vent.

**Furnaces without exhaust air pipe or with catalytic converter (B):** We recommend feeding the exhaust air through a flue.

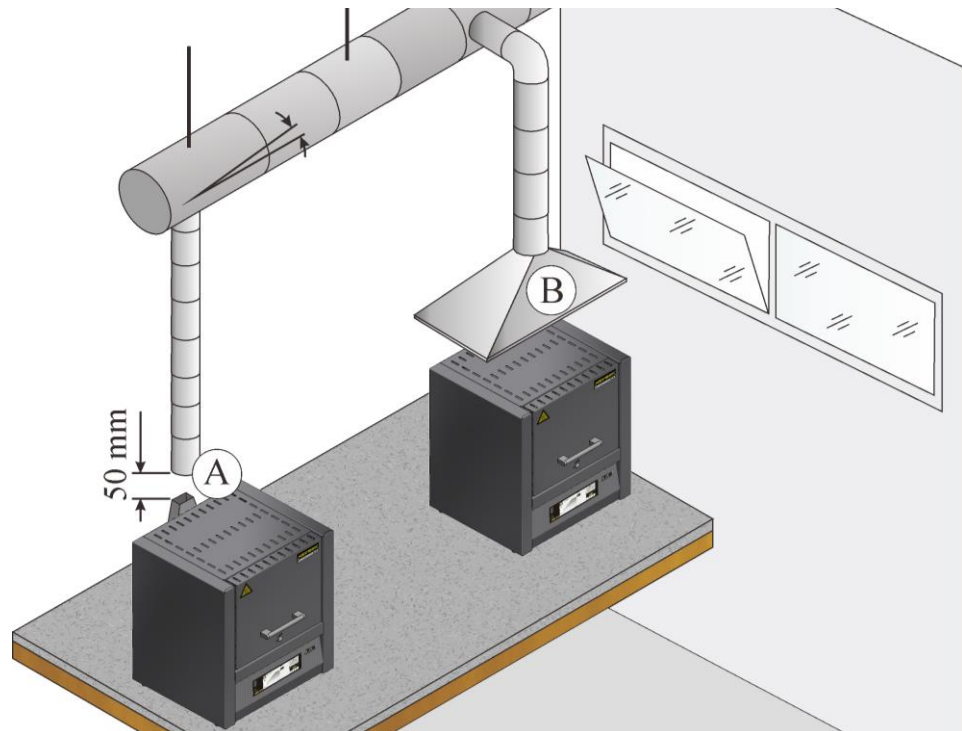


Fig. 25: Example: Various ways of removing the exhaust air



**Note**

Exhaust gases can be vented only if the room is ventilated with a corresponding fresh air inlet.



**Note**

Roof work and/or masonry by the customer is required for the exhaust gas extraction. The size and design of the exhaust gas system must be defined by a ventilation engineer. The accident prevention regulations applicable in the country where the furnace is installed must be observed.

## 5.5.4 Insertion of the Base Plate

Carefully install the insert plate(s)\* (the number of insert plates depends on the furnace model) into the center of the furnace bottom. When installing the insert plate(s), ensure that the door collar and heating elements are not damaged. It is essential not to touch the heating elements when installing the insert plate(s), this can lead to immediate destruction of the heating elements.

The furnace bottom is made of high-quality refractory material, but this material is extremely sensitive to impact and pressure.

To prevent damage to the soft furnace bottom, some models are supplied with an insert plate as standard. Nabertherm shall not be liable for damage (for example, marks) to the furnace bottom if these insert plates\* are not used.

The feeder should be positioned as centrally as possible in the bottom of the furnace chamber. This ensures even heating. Avoid placing insert plates into the furnace in multiple layers. This causes heat to accumulate, which burns out the heating elements and damages the insulation.

When the furnace has been charged, carefully close the furnace door.

\* Included in delivery depending on the version/furnace model



### Note

It must be ensured that the load on the furnace base does not exceed 2 kg/dm<sup>2</sup>.



### Note

For the L(T) 3/11 and L(T) 3/12 models, an insert plate (691600176) is included in the scope of delivery and is supplied as standard.

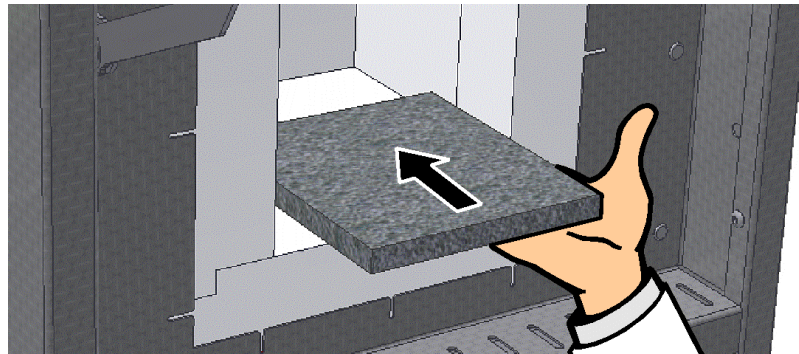


Fig. 26: Inserting the ceramic insert plate (in scope of delivery depends on design/furnace model) (similar to picture)

### 5.5.5 Installing the Scale on the L(T).../.../SW Model

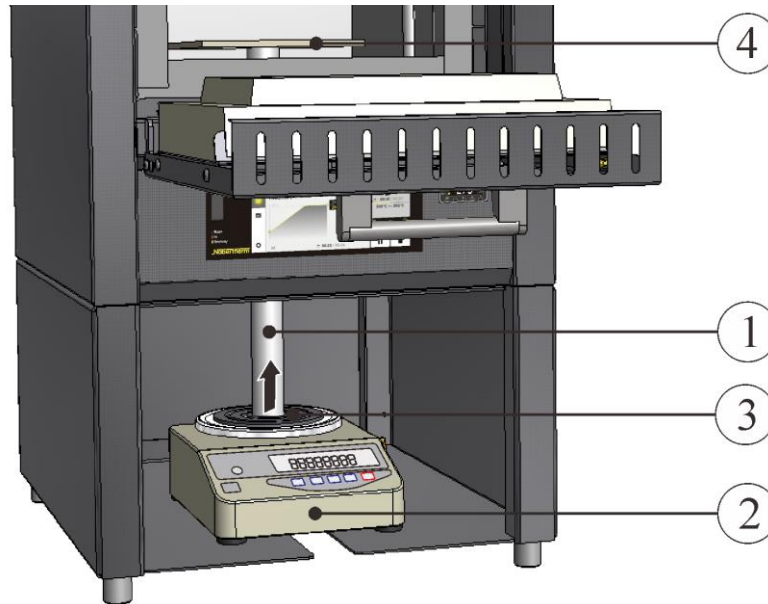


Fig. 27: Scale (similar to picture)

- Carefully insert the ceramic plunger (1) into the hole in the bottom of the furnace from below. Completely open the slider used to seal the opening.
- Place the scale (2) in the bracket beneath the furnace. Carefully lift the tube and place on the surface of the scale.
- To secure the tube, slide the die (3) between the tube and the surface of the scale. To do this, carefully lift the tube.

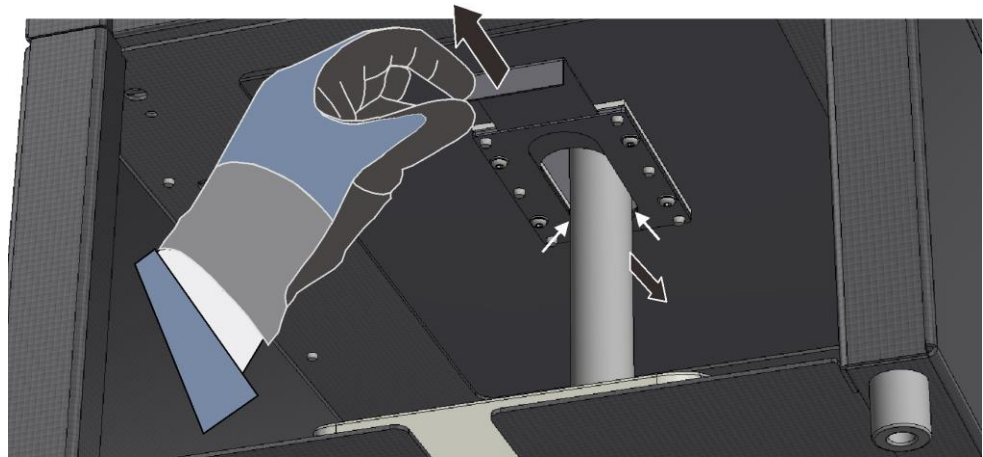


Fig. 28: Opening the slider for sealing the opening (similar to picture)

- Inside the furnace, align the ceramic plate (4) exactly on the center of the tube. To ensure that results are not falsified, the tube must stand freely on the scale and must not touch the insulation or slider. Make sure that the gap (X) is even.

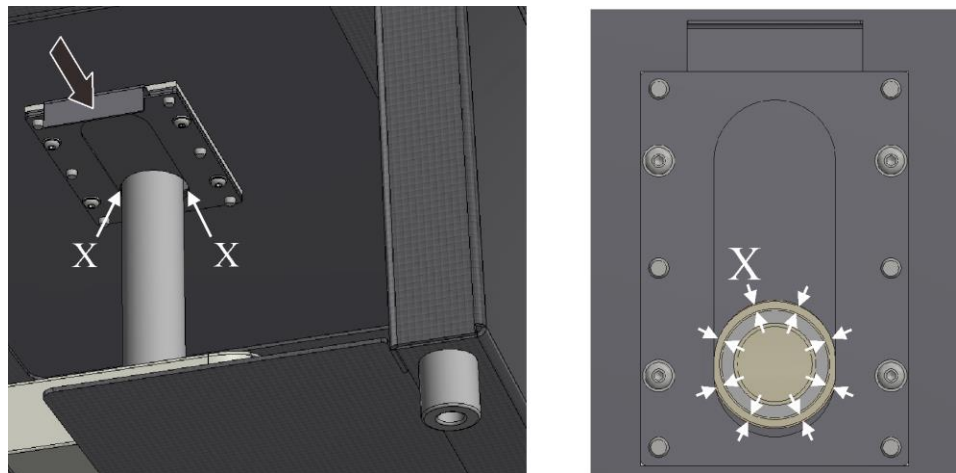


Fig. 29: Closing the slider for sealing the opening (similar to picture)

- Connect the scale with the plug.
- Regarding the functions of the scale: refer to the separate instructions.
- Separate instructions for VCD software (optional)

### 5.5.6 Initial Start-Up

The furnace may be put into operation only by qualified persons and in compliance with the safety instructions.

Read the section on "Safety". When the furnace is put into operation, the following safety information must also be observed to prevent serious injury, damage to the furnace, and damage to other property.

Make sure that the instructions and information in the controller instructions are observed and followed.

The furnace may be used only for its intended purpose.

Ensure that only authorized persons remain in the working area of the furnace and that no other persons are put at risk when the furnace is put into operation.

Before starting the furnace for the first time, make sure that all tools, foreign parts, and transportation securing equipment have been removed.

Activate all safety equipment (power switch, emergency stop button if applicable) before putting the furnace into operation.

Incorrectly wired connections may destroy electric/electronic components.

Observe the special protective measures (e.g. grounding, ...) for components that are at risk.

Faulty connections can cause the furnace to start unexpectedly.

Before you switch on the furnace, make sure that you know what to do in case of faults or emergencies.

Before starting the furnace for the first time, check the electrical connections and control displays.

Before placing materials in the furnace, check whether they could harm or destroy the insulation or the heating elements. Materials that could damage the insulation include: alkalis, alkaline earths, metal vapors, metal oxides, chlorine compounds, phosphorous compounds, and halogens.



#### Note

Before starting the furnace for the first time, allow it to acclimatize at its installation location for 24 hours.



## 5.5.7 Recommendations for Heating Up the Furnace for the First Time



The furnace **must first be heated up** to dry out the masonry and generate a protective oxidated layer on the heating elements.

During the heating up the furnace may give off unpleasant odors, which is due to the release of binding agents from the insulation material. We recommend that the furnace location be well ventilated during the first warm-up phase.

- Warm up the empty furnace over a period of roughly **6 hours<sup>1)</sup> to 1050 °C (1922 °F)**. Hold this temperature for roughly 1 hour.
  - Warm up LE .../... models to 1000 °C (1832 °F) (without the warm-up ramp).
  - After the first warm-up phase, let the furnace cool down naturally to room temperature.
  - The furnace is now ready to operate
- 1) Warm-up ramp




### Caution


This procedure must be performed at the time the furnace is commissioned, following the replacement of heating elements or to regenerate the oxidated layer.

## 6 Operation

### 6.1 Turning on the Controller/Furnace

Turning on the controller		
Procedure	Display	Comments
Turn on the power switch		Set power switch to "I". (Power switch type varies according to design/furnace model)
The furnace status is displayed. After a few seconds, the temperature is displayed.		When the temperature is shown on the controller, the controller is ready for operation.

### 6.2 Turning off the Controller/Furnace

Turn off the controller		
Steps	Display	Comments
Turn off the power switch		Turn off the power switch by setting it to "O" (power switch type differs depending on features/furnace model)

All the necessary settings for perfect functions have already been made at the factory.

### 6.3 Controller 500 Product Line

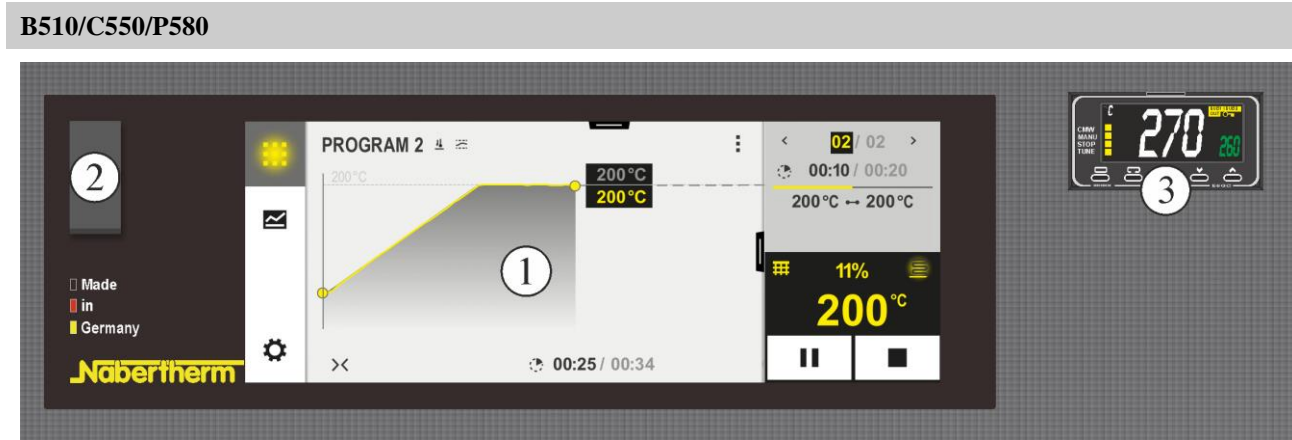


Fig. 30: Control field B510/C550/P580 (similar to picture)

No.	Description
1	Display
2	USB interface for a USB stick
3	Over-temperature limiter with manual reset (optional)



**Note**

See the separate operating instructions for a description of how to enter temperatures and times and to “start” the furnace.

### 6.4 Operating Controller R7

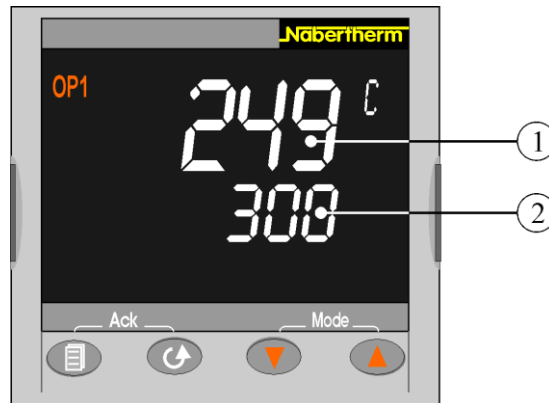





Fig. 31: Controller R7 (similar to picture)















Two temperatures are shown in the display.  
 At the top is the actual value (1).  
 Beneath this is the specified target temperature (2).

249 °C  
 300









**Setting the Setpoint:**

















Button	Description	Display
	From the main display: Use   to increase or decrease the setpoint. The device applies the new setpoint as soon as the button is released. A brief flash indicates that the value is now current.	300 °C 249 °C
<b>Note</b>	When delivered, this controller is set as a fixed setpoint controller. But for several processes it is important that the temperature is raised slowly for the first firing. A ramp function can be set on Controller R 7 for this purpose.	

**Setting a Temperature Ramp:**















Button	Description	Display
	Press  until "SP.RAT" appears in the display.	OFF SP.RAT
	Use   to set the required heating ramp in °C/min (Example 2 °C/min) Increase the value with  (OFF ... 1,9; 2) Decrease the value with  (2 ... 0,1; OFF) Wait 2 seconds until the setting is applied automatically (display flashes 1x).	2 OFF SP.RAT
	Press  to go to the main display.	249 °C 300
	Use   to change a setpoint to the required value. The set rate is used only when the setpoint has been changed. The rate can be used for heating or cooling. The starting temperature of the rate is always the actual temperature. If the target temperature is set below the actual temperature, it is a cooling rate. When a rate has started, "RUN" is shown in the display. Increase the value with  Decrease the value with 	249 °C 300 RUN
<b>Note</b>	If the ramp mode is no longer needed, set the parameter "SP.RAT" to OFF again.	

**Automatic Adjustment of the Control Parameters to the Process Characteristic:**

Button	Description	Display
	Press  for >5 seconds until "Lev1" appears in the display.	LEv1 GOTO
	Press  1x until "LEv2" appears in the display and wait for 2 seconds - the display changes to "0"	LEv2 0
	Press  2x until code "2" is displayed and wait 2 seconds. (The display returns to the main display)	2 550 °C
	Press  until "A.TUNE" appears in the display.	OFF A.TUNE

Button	Description	Display
 	Use   to set OFF or ON. Change with  (ON) Change with  (OFF) Wait 2 seconds until the setting is applied automatically (display flashes 1x).	<b>ON</b> <b>OFF</b> <b>A.TUNE</b>
	Press  until you return to the main display.	<b>249 °C</b> <b>300</b>
 	Use   to set the required temperature in °C (Example 100 °C). (During optimization, TUNE flashes in the display). When optimization is finished, the determined control parameters are applied automatically.	<b>100 °C</b> <b>0 °C</b>
	Press  for >5 seconds until "Lev2" appears in the display.	<b>LEV2</b> <b>GOTO</b>
	Press  1x until "LEV1" appears in the display and wait 2 seconds. Input finished.	



#### Manual Adjustment of the Control Parameters to the Process Characteristic:

Button	Description	Display
	Press  for >5 seconds until "Lev1" appears in the display.	<b>LEV1</b> <b>GOTO</b>
	Press  1x until "LEV2" appears in the display and wait for 2 seconds - the display changes to "0"	<b>LEV2</b> <b>0</b>
	Press  2x until code "2" is displayed and wait 2 seconds. (The display returns to the main display)	<b>2</b> <b>550 °C</b>
	Press  until "PB", "TI", "TD" appear in the display PB: Proportional Band TI: Integral Time TD: Differential Time	<b>5</b> <b>PB</b>
 	Set the required parameters with   (Example 10) Increase the value with  (OFF/1 ... 9; 10) Decrease the value with  (10... 2; 1/OFF) Wait 2 seconds until the setting is applied automatically (display flashes 1x).	<b>10</b> <b>5</b> <b>PB</b>

## 6.5 Over-Temperature Limiter with Manual Reset and Adjustable Cutout Temperature (Additional Equipment)



Fig. 32: Over-temperature limiter with manual reset (similar to picture)

Button	Description	Display
	The over-temperature limiter (2z) monitors the temperature in the furnace. The display shows the trigger temperature that was last set. If the furnace temperature rises above the set trigger temperature, the heating is switched off to protect the furnace and the charge. “ALM” alarm flashes on the over-temperature limiter.	260 °C  ALM
	If the thermocouple sensor breaks, the over-temperature limiter switches the heating off to protect the furnace and the charge. “S.ERR” is displayed on the over-temperature limiter.	S.ERR
	If the temperature in the furnace falls <b>below the value set on the over-temperature limiter</b> , press the following buttons to enable the heating so that the furnace can continue to operate:	
	<b>Enable heating:</b>	
⏪PF	Press ⏪PF for one second. The alarm message of the over-temperature limiter is reset and the heating is enabled.	
	<b>Setting the trigger temperature:</b>	
⏩ ⏪	Use the ⏩ ⏪ buttons to set the required trigger temperature (example 270 °C) Increase the value with ⏩ (260 ... 269, 270) Decrease the value with ⏪ (270 ... 261, 260) To change the value quickly: press and hold ⏩ ⏪.	270 ↗ 260
	 <p>270 °C (518 °F)  260 °C (500 °F)</p> <p>Wait 1 second until the set trigger temperature is applied automatically. <b>Note:</b> Premature triggering of the over-temperature limiter can be avoided if the difference between the adjustable furnace temperature and the trigger temperature is not less than 10 °C.</p>	
	The display jumps back to the start screen showing the trigger temperature. The current trigger temperature is displayed. Input finished.	270 °C



For further information about operation, refer to the separate OMRON E5GC operating instructions.



### DANGER

- **Danger caused by incorrectly entered cut-off temperature at the over-temperature limiter/over-temperature limiter with motor driven reset**
- **Risk of fatal injury**
- If, as a result of over-temperature from the charge and/or the operating equipment, a charge is likely to be damaged at this pre-set cut-off temperature of the over-temperature limiter/over-temperature limiter with motor driven reset, or if the charge itself becomes a source of danger for the furnace or its surroundings, the cut-off temperature must be reduced on the over-temperature limiter/over-temperature limiter with motor driven reset to the maximum permissible value.

## 6.6 Loading/Charging

### Charging the Furnace

The insulation is made of high-quality refractory material but is highly sensitive to impact. Avoid contact when charging to prevent any damage.

To obtain a temperature distribution which is as uniform as possible it is advantageous to leave space between the pieces and between the pieces and the side walls. Nabertherm supplies insert plates (base plate) and the like to help you make use of the furnace chamber.

Loading a very large quantity of ware into the furnace chamber can substantially lengthen the heating-up time.

The furnace heating system is interrupted if the door is opened. After the door is reclosed, it is automatically switched on again (not applicable to LE .../... models).

If it can be at all avoided, do not open the furnace when it is hot. When it is necessary to open the furnace at a high temperature, the time should be kept to an absolute minimum. Make sure that operators wear the appropriate protective clothing and that the workspace is adequately ventilated.

Always make sure that the door is completely closed.

Stainless steel sheet can discolor (especially if the furnace is opened while hot). This does not impair functionality in any way. This is no reason for a complaint.

#### **Caution LE .../... Models:**

Continuous operation at maximum temperature can lead to increased wear of the heating elements and the door seal. We recommend operating at approx. **50 °C below the maximum temperature.**

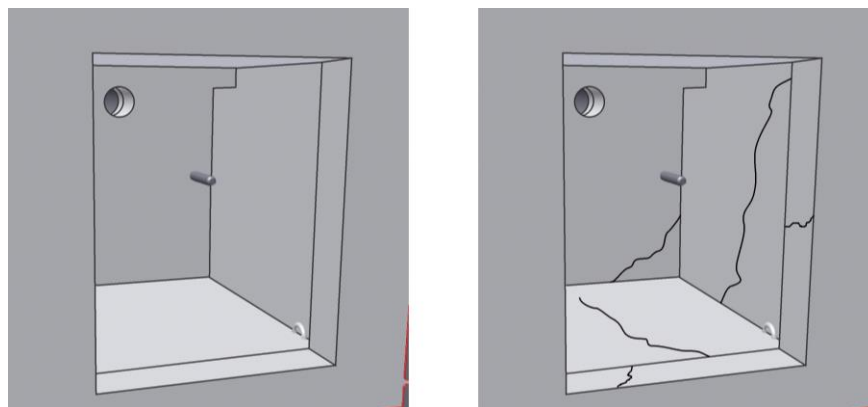


### **Warning - Danger of Electric Shock!**

For the protection of the operator and the furnace the heating program must be stopped before the furnace is loaded.

### Cracks in the insulation

The insulation of the furnace and/or the heating plates in the furnace (depending on model) are made from very high-quality refractory material. Due to thermal expansion, after just a few heating cycles cracks form in the insulation and, under certain circumstances, also on the heating plates. These have no effect on the function, safety or quality of the furnace. This is not a reason for complaint.



Before

After

Fig. 33: Example: Cracks in the insulation after a few heating cycles

## 6.7 Inserting the base plate and/or catch basin (accessories)

Nabertherm offers various base plates and catch basins to protect the furnaces and enable easy charging.

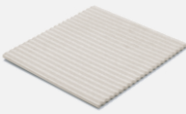

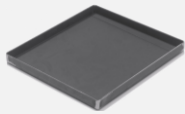
For model	Ceramic ribbed tile, Tmax 1200 °C	Ceramic collecting pan, Tmax 1300 °C	Steel collecting pan, (material 1.4828) Tmax 1100 °C
			
	Article number/dimensions in mm		
L 1, LE 1	691601835 110 x 90 x 12.7	-	691404623 85 x 100 x 20
LE 2	691601097 170 x 110 x 12.7	691601099 100 x 160 x 10	691402096 120 x 180 x 20
L 3, LT 3, LV 3, LVT 3	691600507 150 x 140 x 12.7	691600510 150 x 140 x 20	691400145 150 x 140 x 20
LE 6, L 5, LT 5, LV 5, LVT 5	691600508 190 x 170 x 12.7	691600511 190 x 170 x 20	691400146 190 x 170 x 20
L 9, LT 9, LV 9, LVT 9	691600509 240 x 220 x 12.7	691600512 240 x 220 x 20	691400147 240 x 220 x 20
LE 14	691601098 210 x 290 x 12.7	-	691402097 210 x 290 x 20
L 15, LT 15, LV 15, LVT 15	691600506 340 x 220 x 12.7	-	691400149 220 x 340 x 20
L 24, LT 24	691600874 340 x 270 x 12.7	-	691400626 270 x 340 x 20
L 40, LT 40	691600875 490 x 310 x 12.7	-	691400627 310 x 490 x 20

Fig. 34: Floor tiles and collecting pans

The base plate/catch basin (included in delivery depending on requirements and application) must be clean and dry before being deposited. Wait until the furnace chamber has cooled down to room temperature before depositing the base plate/catch basin on the furnace bottom.

Open the furnace door and carefully position the base plate/catch basin in the center of the furnace bottom and push it against the rear wall of the furnace as far as it will go. The furnace bottom must be flat and clean; vacuum the furnace bottom if required.

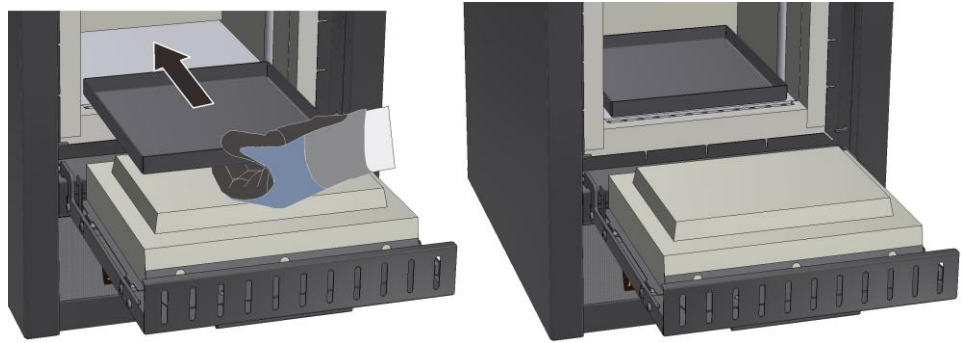


Fig. 35: Example: Careful depositing of the catch basin (similar to picture)

When inserting the base plate/catch basin into the furnace, be careful not to slide it over the insulation of the door. The insulation of the door is extremely sensitive and would wear out and lose insulation as a result from sliding the base plate/catch basin.



Fig. 36: Example: Avoid damaging the door insulation (similar to picture)



**Note**

The use of a base plate or catch basin to protect the furnace bottom is always recommended.

## 6.8 Fresh Air Valve

The quantity of the supplied air can be set using the adjustable fresh air inlet. The setting is explained by the symbols located over or on the sliding valve.

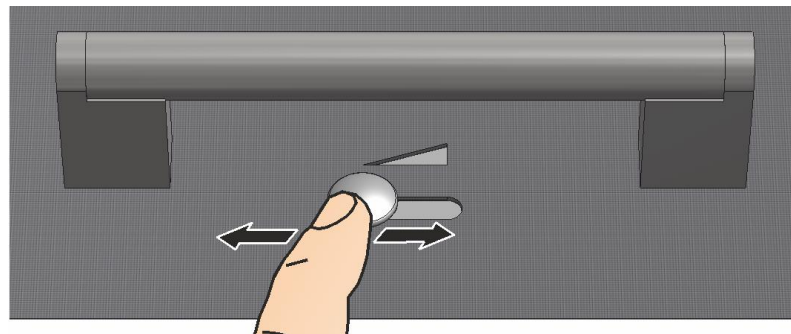


Fig. 37: Air supply sliding valve (similar to picture)



Symbol Definitions (depending on the furnace model)		
Symbol	closed	maximum opened
A		
B		
Operation during protective gas application with retort		can remain opened
Operation without protective gas		Depending on the process
Operating during rapid cooling via compressed air		closed

Fig. 38: Regulation of the fresh-air supply (symbols)



**Notice for the Use of Catalytic Converters and Exhaust Vent Fan:**

The air feed lever must always be set to ● because the exhaust gases cannot be adequately vented from the furnace chamber.



**Note**

If the fresh air lever is open, under certain circumstances this may affect temperature uniformity in the furnace chamber.

## 6.9 Stackable Saggar (Accessories)

Nabertherm offers special-purpose saggars for charging the furnace.

For optimum utilization of the furnace chamber, the material is placed in ceramic saggars. Saggars can be stacked in several levels, depending on the furnace model. The saggars have slits to allow the air to circulate. The top saggar can be closed with a ceramic lid.

Charging on several levels	Saggar	Lid for saggars
	Article number: 699000279	Article number: 699000985

Fig. 39: Saggar with lid



**Note**

The accessories described above are designed for cold charging and discharging. Removing the accessories in hot condition is not possible.

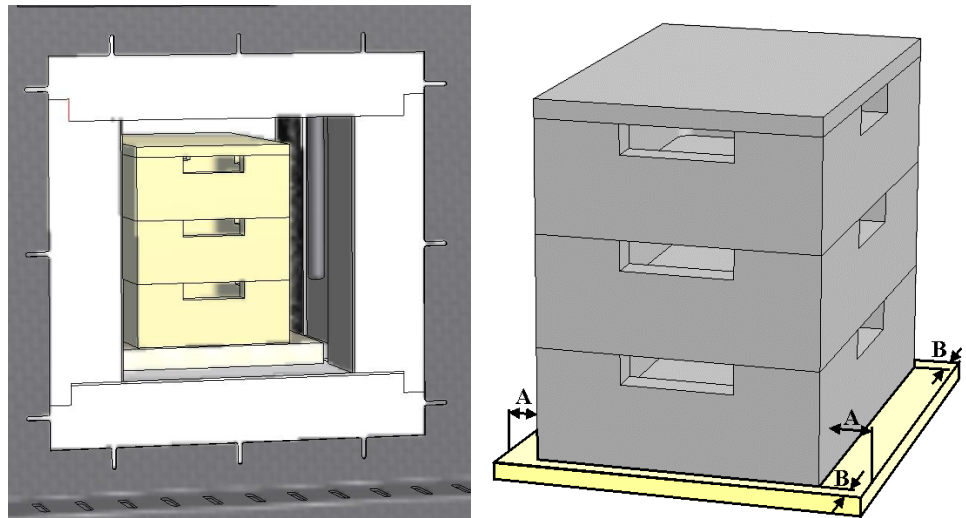


Fig. 40: Safe charging on up to three levels (similar to picture)

The lowest charge saggars must be positioned in the middle on the floor board (ceramic insert board) to ensure uniforming heating of the charge.

When charging make sure that neither the door collar nor the heating elements are damaged. Make absolutely no contact with the heating elements. Any contact with the heating elements can result in their destruction.

After charging, the furnace door must be closed carefully. The insulation of the furnace door must not push the charge saggars into the furnace chamber.



**Warning - Danger of Electric Shock!**

For the protection of the operator and the furnace, the heating program must be stopped before the furnace is loaded. Ignoring this warning can result in electric shock.

## 7 Servicing, Cleaning, and Maintenance



**Warning - General Hazards!**

Cleaning, lubrication, and maintenance tasks may only be performed by authorized experts following the maintenance instructions and accident protection guidelines. We recommend that maintenance and repair be performed by Nabertherm GmbH Service. Failure to comply runs the risk of bodily injury, death, or significant property damage!



**Warning - Danger due to Electrical Current!**

Work on the electrical equipment may only be performed by qualified, authorized electricians!



During maintenance work, the voltage supply to the furnace and/or switching system must be switched off to prevent unintentional commissioning. Disconnect the mains power connector due to reasons of safety.

Operators may only correct malfunctions which are obviously due to operational error! Wait until the furnace chamber and attaching parts have cooled to room temperature.

The furnace must be visually inspected at regular intervals for damage. The interior of the furnace must also be cleaned as required (e.g. vacuuming out) **Attention:** Do not bang against the heating elements to avoid breaking them.

While work is being performed on the furnace, the furnace and work room must additionally be ventilated with fresh air.

Safety systems removed during maintenance tasks must be replaced after the work.

Warning of swinging loads in the workshop (e.g. crane systems). Work under a lifted load (e.g. a lifted furnace or switching system) is not permitted.

Safety switches and any limit switches present must be checked for function periodically (DGUV V3) or according to the national guidelines of the country of operation.

To ensure proper temperature regulation of the furnace, the thermocouple must be checked for damage before every process.

If necessary, retighten the element holders (see chapter "Replacing the Heating Element"). Before carrying out this work, the voltage supply to the furnace and/or switching system must be switched off (disconnect mains power connector). The regulations (DGUV V3) or corresponding national regulations in the relevant country of operation must be observed.

There are one or more contactors in the control system. The contacts of these circuit breakers are wearing parts and must therefore be serviced and/or replaced regularly (DGUV V3) or according to the national guidelines of the country of operation.

The switching system cabinet (if available) contains vent grilles with integrated filter mats. These must be cleaned and/or replaced at regular intervals in order to ensure sufficient intake and outflow of air from the switching system. During melting operation, the switching cabinet door must always be firmly closed.



**Note**

If hazardous substances have been spilled on or inside the equipment, proper decontamination must be performed.

**7.1 Furnace Insulation**



**During the work on the insulation or the replacement of components in the furnace chamber, the following points must be observed:**

When repairs are made or demolition work is performed, silicon dust may be released. Depending heat-treated materials contained in the furnace, further contaminants may be contained in the insulation. To exclude possible health risks, dust concentrations must be kept to a minimum during any work performed at or near the insulation. In many countries there are specific occupational safety limits. You can acquire more relevant information by investigating the relevant legal specifications in your country.

Dust concentrations should be kept as low as possible. Dust must be removed using a suction device or a vacuum cleaner with a high-performance filter (HEPA – category H). Strong air currents such as drafts, for example, must be prevented. Pressurized air or brush must not be used for cleaning. Piles of dust must be sprinkled.

During work on the insulation a respirator mask with an FFP2 filter or an FFP3 filter must be used. The work clothing must be loose and cover the body completely. Gloves and goggles must be worn. Soiled clothing should be cleaned before it is removed with a vacuum cleaner equipped with a HEPA filter.

Contact with skin and eyes should be avoided. The impact of fibers on skin or eyes can lead to mechanical irritation which, in turn, causes reddening and itchiness. After completing the work, or after direct contact, the skin must be washed with soap and water. If there is

contact with the eyes, they must be washed out carefully for several minutes. If necessary, an eye doctor should be consulted.

Smoking, eating and drinking at the workplace is prohibited.

When working on insulation, the Technical Regulations for Hazardous Materials must be applied in Germany. <http://www.baua.de> (German).

Additional information regarding how to handle fibrous materials can be found at <http://www.ecfia.eu> (English).

When the materials are discarded, national and regional guidelines must be observed. The possible presence of hazardous contaminants generated by the furnace process must be taken into account.

### Refractory bricks

The refractory bricks (insulation) are of a particularly high quality. Due to the manufacturing process small holes or cavities may occur. These are quite normal and underline the quality features of the bricks. These holes or cavities are not a reason for complaint.

## 7.2 Shutting the System Down for Maintenance

**Wait until the furnace chamber and attached parts have cooled to room temperature.**

- The furnace must be completely emptied
- Inform operating personnel and name supervisors
- Switch off main switch and/or disconnect the power cord.
- Lock the main switch (if available) and secure against restoration of power using a padlock.
- Attach a warning sign on the main switch
- Clean up the maintenance area as far as possible.
- Check for disconnection of power.
- Ground and short-circuit the working area.
- Cover any nearby parts still under power.



#### **Warning - Dangers During Normal Operation!**

Do not touch any object without first having checked its temperature.



#### **Warning – Danger of Electric Shock**

Work on the electrical equipment may be done only by qualified, authorized electricians. During work it must be ensured that the furnace and the switching equipment cannot be activated by mistake (pull out the power plug) and that all moving parts in the furnace are secured. Observe DGUV V3 or the corresponding national regulations in the country where the furnace is installed. Wait until the furnace and the connected parts have cooled to room temperature.

### 7.3 Regular Maintenance of the Furnace

Warranty and liability claims for personal injury and material damage shall be excluded if regular maintenance work is not observed.

Component/ item/ function and action	Comment	A	B	C
<b>Safety test in accordance with DGUV V3 or corresponding national regulations</b> Pursuant to regulation				X2
<b>Safety and limit switch (if present)</b> Function test			D	X2
<b>Furnace chamber, extraction holes and extraction tubes</b> Clean and inspect for damage; vacuum carefully			M	X1
<b>Sealing surfaces: Door collar/furnace collar</b> Visual inspection			D	X1
<b>Heating elements</b> Visual inspection (visible part of the heating element inside the furnace chamber)			D	X1
<b>Check for uniform power consumption of the heating system</b> Function test			Y	X2
<b>Thermocouple</b> Visual inspection (visible part of the heating element inside the furnace chamber)			D	X1
<b>Over-temperature limiter (if present) – check setting value</b> Set the correct switch-off temperature on the over-temperature limiter for the maximum charge temperature. For each change in the heat treatment program, check the cutout temperature (alarm value) on the over-temperature limiter				X1
<b>Key:</b> see “Maintenance Table Key”				



**Warning – Danger of Electric Shock!**

Work on the electrical equipment may be done only by qualified, authorized electricians.



**Notice**

Maintenance work must be performed only by authorized persons, observing the maintenance instructions and the accident prevention regulations. We recommend that maintenance and repair work be carried out by the service team of Nabertherm GmbH.

## 7.4 Regular Maintenance Tasks – Documentation

Component/ item/ function and action	Comment	A	B	C
Type plate Legible		-	Y	X1
Operating instructions Ensure they are kept near the furnace		3	Y	X1
Component instructions Ensure they are kept near the furnace		3	Y	X1
<b>Key:</b> see “Maintenance Table Key”				

## 7.5 Maintenance Table Key

Symbols:	
<b>A = Spare Part Stocks</b>	<b>1</b> = Stocks urgently recommended <b>2</b> = Stocks recommended / <b>3</b> = As required, not relevant
<b>B = Maintenance Interval</b> <b>Notice:</b> If ambient conditions are severe, the maintenance intervals must be shorter.	<b>D</b> = Daily, each time before the furnace is started <b>W</b> = Weekly <b>M</b> = Monthly / <b>Q</b> = Quarterly <b>Y</b> = Yearly /
<b>C = Performed by</b>	<b>X1</b> = Operating personnel <b>X2</b> = Specialist personnel

## 7.6 Cleaning Products



### Note

If hazardous substances have been spilled on or inside the equipment, proper decontamination must be performed.



Observe the procedure for shutting down the furnace (see “Operation”). Then remove the power plug from the socket. Allow the furnace to cool naturally.

Use commercial cleaning products that are either water-based or non-flammable and free of any solvents to clean the housing of any deposits; use a vacuum cleaner for the interior.

**Pay attention to the labeling and information on the cleaning product packaging.**

Wipe the surface with a damp, lint-free cloth. You may also use the following cleaning products:

### This List must be Completed by the Operator.

Component and Position	Cleaning Product
Outer surfaces (frames)*	Use commercial cleaning products that are either water-based or non-flammable and free of any solvent*

<b>This List must be Completed by the Operator.</b>	
<b>Component and Position</b>	<b>Cleaning Product</b>
Outer surface (stainless steel)	Stainless steel cleaner
Inside	Carefully clean with a vacuum cleaner (avoid the heating elements)
Insulation materials	Carefully clean with a vacuum cleaner (avoid the heating elements)
Door seal (if applicable)	Use commercial cleaning products that are either water-based or non-flammable and free of any solvent
Instrument panel	Wipe the surface with a damp, lint-free cloth. (e.g. glass cleaner)

\*You must be sure that the cleaner does not damage the water-soluble, environmentally safe paint (test the product on an interior, hidden area).

Fig. 41: Cleaning products





Clean quickly to protect the surfaces.

Remove the cleaning product completely from the surfaces by wiping them with a damp, lint-free cloth.

After cleaning, check all supply lines and connections for leaks, loose connections, abrasion and damage; report any defects immediately!

See “Environmental Protection Regulations”.

► **Note**  
 The furnace, the furnace chamber and attached components must **NOT** be cleaned with a high-pressure cleaner.

 	 <b>DANGER</b>	
	<ul style="list-style-type: none"> <li>• <b>Danger of electric shock.</b></li> <li>• <b>Risk of fatal injury</b></li> <li>• Before cleaning, pull out the power plug.</li> <li>• Do NOT pour water or cleaning products over the inside or outside surfaces</li> <li>• Allow furnace to dry completely before operating it again</li> </ul>	

## 8 Malfunctions

Work on the electrical system may be done only by qualified, authorized electricians. Operators may only rectify malfunctions that are obviously due to operating errors.

Call your local electrician for malfunctions that you cannot localize.

If you have any questions, problems, or requirements, contact Nabertherm GmbH. By mail, phone, or e-mail -> See "Nabertherm Service".

Phone advice is free and non-binding for our customers – all you pay is the phone costs.

In case of mechanical damage, send an email containing the above information and a digital photo of the damaged part and a photo of the complete furnace to the following address:

-> see "Nabertherm Service".

If a malfunction cannot be rectified with the described solutions, contact our service hotline directly.

Have the following information at hand when you phone. This makes it easier for our customer service to answer your questions.

## 8.1 Error Messages of the Controller

The controller shows the error messages and warnings on the screen until they have been rectified and acknowledged. It may take up to one minute until these messages are transferred to the archive.

ID+ Sub-ID	Text	Logic	Remedy
<b>Communication error</b>			
01-01	Bus zone	Communication connection to a control module disrupted	Check that the control module is firmly attached LEDs on the control modules red? Check the cable between the control unit and the control module Plug of the connection cable not plugged correctly into the control unit
01-02	Bus communications module	Communication connection to the communications module (Ethernet/USB) disrupted	Check that the communications module is firmly attached Check the cable between the control unit and the communications module
<b>Sensor error</b>			
02-01	TC open		Check thermocouple, thermocouple terminals and cable Check contacts of the thermocouple cable in plug X1 on the control module (contacts 1+2)
02-02	TC Connection		Check the set thermocouple type Check poles of thermocouple connection
02-03	Compare point error		Control module defective
02-04	Compare point too hot		Temperature in the switchgear too high (approx. 70 °C) Control module defective
02-05	Compare point too cold		Temperature in the switchgear too low (approx. -10 °C)
02-06	Encoder separated	Error at the 4-20 mA input of the controller (<2 mA)	Check 4-20 mA sensor Check the connection cable to the sensor
02-07	Sensor element defective	PT100 or PT1000 sensor defective	Check PT sensor Check connection cable to the sensor (cable break/short circuit)



ID+ Sub-ID	Text	Logic	Remedy
<b>System error</b>			
03-01	System memory		Error after firmware updates <sup>1)</sup> Defective control unit <sup>1)</sup>
03-02	ADC error	Communication between AD converter and controller disrupted	Replace control module <sup>1)</sup>
03-03	File system defective	Communication between display and memory chip disrupted	Replace control unit
03-04	System monitoring	Program execution on the control unit defective (Watchdog)	Replace control unit USB flash drive removed too soon or defective Switch controller off and on again
03-05	Zone system monitoring	Program execution on a control module defective (Watchdog)	Replace control module <sup>1)</sup> Switch controller off and on again <sup>1)</sup>
03-06	Self-test error		Contact Nabertherm Service <sup>1)</sup>
<b>Monitoring</b>			
04-01	No heater power	No temperature increase in the ramps when heating output $\leq$ 100 % for 12 minutes and when the temperature setpoint is higher than the current furnace temperature	Acknowledge the error (if necessary, disconnect from the power supply) and check safety contactor, door switch, heating controls and controller. Check heating elements and heating element connections. Lower D value of the control parameters.
04-02	Excess temperature	The temperature of the control zone exceeds the max. program setpoint or the maximum furnace temperature by 50 Kelvin (from 200 °C) The equation for the switch off threshold is: Maximum program setpoint + zone offset of the master zone + charge control offset [Max] (if charge control active) + excess temperature switch-off threshold (P0268, e.g., 50 K)	Check solid state relay Check thermocouple Check controller  (from V1.51 with 3 minute delay)

ID+ Sub-ID	Text	Logic	Remedy
		A program was started at a furnace temperature higher than the maximum setpoint in the program	Do not start the program until the furnace temperature is lower. If this is not possible, insert a hold time as a start segment and then a ramp with the desired temperature (STEP=0 minutes duration for both segments) Example: 700 °C -> 700 °C, Time: 00:00 700 °C -> 300 °C, Time: 00:00 The normal program begins here From Version 1.14, the actual temperature is also considered at the start.  (from V1.51 with 3 minute delay)
04-03	Power failure	The set limit for restarting the furnace was exceeded	If possible, use an uninterruptible power supply
		The furnace was switched off at the main switch during the program	Stop the program on the controller before you switch off the main switch
04-04	Alarm	A configured alarm was triggered	
04-05	Auto-tune failed	The determined values are implausible	Do not carry out auto-tune at the lower temperature range of the furnace working range
	Battery weak	Time is not shown correctly. A power failure may no longer be handled properly.	Export all parameters to a USB flash drive Replace the battery (see “Specifications”)
<b>Other malfunctions</b>			
05-00	General malfunction	Malfunction in the control module or Ethernet module	Contact Nabertherm Service Provide the service export

## 8.2 Warnings of the Controller

Warnings are not displayed in the error archive. They are only displayed on the display and in the file of the parameter export. Warning do not generally lead to a program crash.

No.	Text	Logic	Remedy
00	Gradient monitoring	The limit value of the configured gradient monitoring was exceeded	For troubleshooting, refer to “Gradient Monitoring” Gradient set too low
01	No control parameters	No “P” value was entered for the PID parameters	Enter at least one “P” value in the control parameters. It must not be “0”
02	Charge thermocouple defective	No charge thermocouple was determined with the current program and activated charge control	Plug in a charge thermocouple Disable charge control in the program Check the charge thermocouple and its cable for damage

No.	Text	Logic	Remedy
03	Cooling thermocouple defective	The cooling thermocouple is not plugged in or is defective	Plug in a cooling thermocouple Check the cooling thermocouple and its cable for damage If there is a malfunction in the cooling thermocouple during active controlled cooling, the system switches over to the thermocouple of the master zone.
04	Documentation thermocouple defective	Either no documentation thermocouple or a defective one was determined.	Plug in a documentation thermocouple Check the documentation thermocouple and its cable for damage
05	Power failure	A power failure was determined. There was no program interrupt	None
06	Alarm 1 - Band	The configured band alarm 1 was triggered	Optimize the control parameters Alarm set too narrowly
07	Alarm 1 - Min	The configured min. alarm 1 was triggered	Optimize the control parameters Alarm set too narrowly
08	Alarm 1 - Max	The configured max. alarm 1 was triggered	Optimize the control parameters Alarm set too narrowly
09	Alarm 2 - Band	The configured band alarm 2 was triggered	Optimize the control parameters Alarm set too narrowly
10	Alarm 2 - Min	The configured min. alarm 2 was triggered	Optimize the control parameters Alarm set too narrowly
11	Alarm 2 - Max	The configured max. alarm 2 was triggered	Optimize the control parameters Alarm set too narrowly
12	Alarm - External	The configured alarm 1 at input 1 was triggered	Check the source of the external alarm
13	Alarm - External	The configured alarm 1 at input 2 was triggered	Check the source of the external alarm
14	Alarm - External	The configured alarm 2 at input 1 was triggered	Check the source of the external alarm
15	Alarm - External	The configured alarm 2 at input 2 was triggered	Check the source of the external alarm
16	No USB flash drive inserted		When exporting data, insert a USB flash drive in the controller

No.	Text	Logic	Remedy
17	Import/export of data via the USB flash drive unsuccessful	The file was edited with a PC (text editor) and saved in the wrong format or the USB flash drive was not detected. You want to import data that is not in the import folder on the USB flash drive	Do not edit XML files with a text editor, only in the controller. Format the USB flash drive (format: FAT32). No quick formatting Use a different USB flash drive (to 2 TB/FAT32) When importing, all data must be in the import folder on the USB flash drive. The maximum storage capacity for USB flash drives is 2 TB/FAT32). If you experience problems with your USB flash drive, use a different USB flash drive with maximum 32 GB
	Programs are rejected during the import of programs	Temperature, time or rate are outside the limit values	Import only programs that are suitable for the furnace. The controllers differ as regards the number of programs and segments and the maximum furnace temperature.
	While programs are being imported, "Error occurred" is displayed	The complete parameter set (at least the configuration files) was not stored in the "Import" folder on the USB flash drive	If you deliberately left out files during import, ignore the message. Otherwise, check the completeness of the import files.
18	"Heating blocked"	This message is displayed if a door switch is connected to the controller and the door is open	Close the door Check the door switch
19	Open door	The furnace door was opened while a program was running	Close the door while a program is running.
20	Alarm 3	General message for this alarm number	Check the cause of this alarm message
21	Alarm 4	General message for this alarm number	Check the cause of this alarm message
22	Alarm 5	General message for this alarm number	Check the cause of this alarm message
23	Alarm 6	General message for this alarm number	Check the cause of this alarm message
24	Alarm 1	General message for this alarm number	Check the cause of this alarm message
25	Alarm 2	General message for this alarm number	Check the cause of this alarm message
26	Multi-zone holdback temperature exceeded	A thermocouple that was configured for multi-zone holdback has left the temperature band downward	Check whether the thermocouple is necessary for monitoring. Check the heating elements and their activation
27	Multi-zone holdback temperature undershot	A thermocouple that was configured for multi-zone holdback has left the temperature band upward	Check whether the thermocouple is necessary for monitoring. Check the heating elements and their activation

No.	Text	Logic	Remedy
28	Modbus connection interrupted	The connection to the superordinate system was interrupted.	Check if the Ethernet cables are damaged. Check the configuration of the communication connection

### 8.3 Malfunctions of the Switchgear

Error	Cause	Remedy
<b>Controller does not light up</b>	Controller is switched off	Switch the power switch to "I"
	No power available	Is the power cord plugged into the socket? Check the building fuses. Check the fuse of the controller (if present) and replace it if necessary.
	Check the fuse of the controller (if present) and replace it if necessary.	Switch the power switch on. If the error occurs again, contact Nabertherm Service
<b>Controller displays error</b>	See the separate instructions of the controller	See the separate instructions of the controller
<b>Furnace does not heat</b>	Door / cover is open	Close the door / cover
	The door contact switch is faulty (if present)	Check the door contact switch
	"Delayed Start" is displayed	The program is waiting for the programmed start time. Deselect delayed start above the start button.
	Error in entering the program	Check the heating program (see the separate instructions of the controller)
	Heating element defective	Have this checked by Nabertherm Service or a qualified electrician.
<b>Very slow heating of the heating space</b>	The fuse(s) of the connection is/are defective.	Check the fuse(s) of the connection and replace if necessary. Notify Nabertherm service if the new fuse fails again immediately.
<b>The program does not jump to the next segment</b>	In one TIME segment in the program input, the wait time is set to INFINITE If charge control is activated, the temperature of the charge is higher than the zone temperatures.	Do not set the wait time to INFINITE
	If charge control is activated, the temperature of the charge is higher than the zone temperatures.	The parameter [LOWER BLOCK] must be set to [NO].


Error	Cause	Remedy
The controller module can not be registered on the operating unit	Addressing error of the controller module	Perform a bus reset and re-address the controller module
The controller is not heating in the optimization	No optimization temperature has been set	The temperature to be optimized must be entered (see the separate instructions of the controller)

The temperature rises faster than the controller setting allows	<p>The switch element of the heating unit (semiconductor relay, thyristor or switch contactor) is defective.</p> <p>Individual defective components inside a furnace cannot be completely ruled out in advance. That is why the controllers and the switchgear units must be equipped with safety facilities. For example, the furnace shuts down the heating unit in response to error message 04 - 02 via an independent contact element.</p>	Have the switch element tested by a qualified electrician and replaced as necessary.
---	---	--

## 8.4 Replacing a Fuse

### 8.4.1 Fuse Located Outside the Switchgear

A fuse is located on the back of the furnace next to the power cable connection. This fuse protects the additional snap-in socket. When inserting a new fuse, make sure that the fuse rating is suitable for the voltage used by your furnace.

	<b>NOTICE</b>
	<ul style="list-style-type: none"> <li>• <b>Damage to the furnace and its components</b></li> <li>• <b>Use of a fuse that is NOT suitable for the respective voltage may damage the furnace and its components and is a fire hazard.</b></li> <li>• Use only a suitable fuse type. Check that the fuse type has the correct nominal current value.</li> </ul>



Carry out the procedure to switch off the furnace (see "Operation"). Then pull the power plug out of the socket. Allow the furnace to cool naturally.

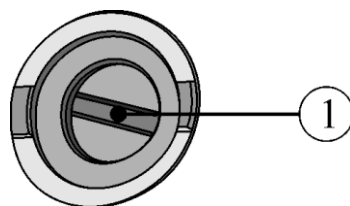


Fig. 42: The fuse is located in the back wall of the furnace.

- Insert a suitable flat blade screwdriver into the slot of the fuse holder. To remove the fuse holder (1), press it in and turn it anti-clockwise. After a few turns, pull the fuse holder out carefully with your fingertips.

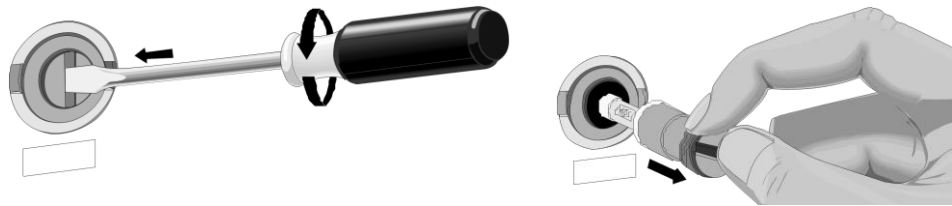


Fig. 43: Release and pull out the fuse holder

- Remove the fuse from the fuse holder.
- Replace the defective fuse with a similar fuse.
- Before you replace the fuse, make sure that it has the correct nominal current. For the correct fuse (fuse link), see "Spare/Wearing Parts".

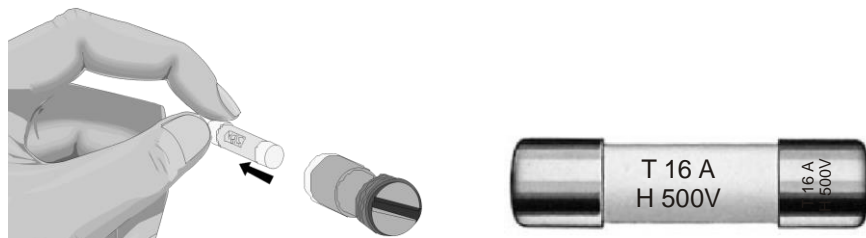


Fig. 44: Remove fuse

Nominal current (Example)



### Note

The nominal current is engraved into the metal cap of the fuse or can be found imprinted directly on the fuse.

- Insert the new fuse into the fuse holder. Make sure that the fuse is pushed fully into the holder.
- Replace the fuse holder slowly and carefully. To fix the fuse holder, insert the flat blade screwdriver into the slot and turn it in a clockwise direction with some pressure.

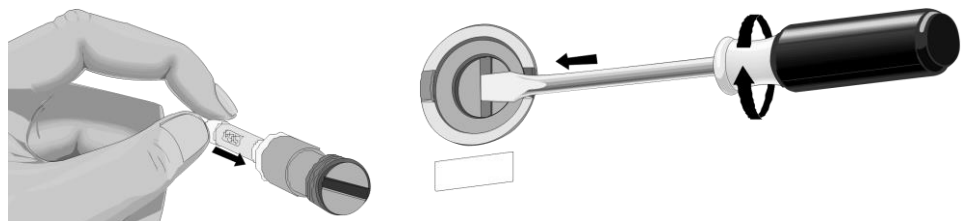


Fig. 45: Insert fuse

- Check that the power cable is not damaged. The power cable must not be damaged. Power cables may be replaced only with similar, approved cables.
- Reconnect the power cable (see "Connecting the Furnace to the Power Supply").
- Switch on the furnace's power switch (see "Operation").

## 8.5 Separate the Snap-In Coupling (Plug) from the Furnace Housing

With a small flat blade screwdriver carefully push the locking latch (2) upward while pulling the plug (3) out of the coupling (4).

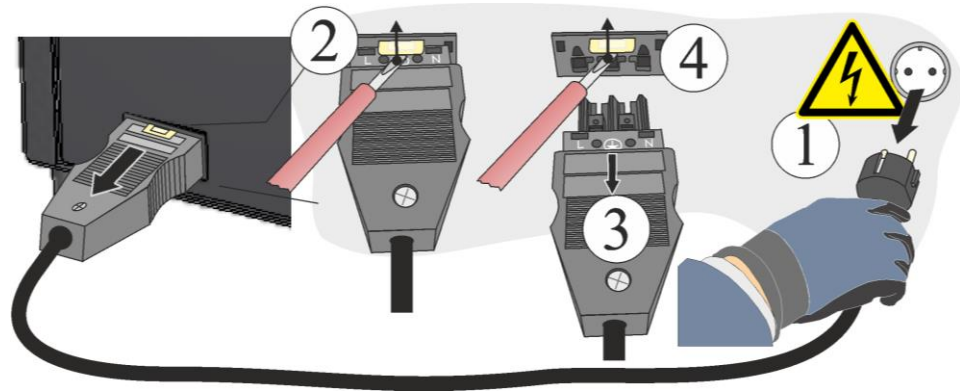


Fig. 46: Separate the snap-in coupling (plug) from the furnace housing (similar to picture)

## 9 Spare Parts/Wearing Parts



### Ordering spare parts:

Our Nabertherm Service team is available worldwide. Due to our high vertical range of manufacture, we deliver most spare parts from stock overnight or can produce them with short delivery times. You can order Nabertherm spare parts directly from the factory quickly and easily. Orders can be made by mail, phone, or e-mail -> see "Nabertherm Service".

### Availability of spare parts and wearing parts:

Although Nabertherm has many spare parts and wearing parts in stock, we cannot guarantee the short-term availability of all of them. We recommend that certain parts be ordered in good time. If you need any assistance when selecting spare parts and wearing parts, the staff at Nabertherm will be glad to help you.

#### Note

Original parts and Accessories are designed especially for Nabertherm furnaces. Replace parts only with original Nabertherm parts. Otherwise the warranty will be void. Nabertherm accepts absolutely no liability for damage caused by using parts that are not original Nabertherm parts.

#### Note

Contact our Nabertherm Service for dismantling and installing wearing/spare parts. See "Nabertherm Service". Work on the electrical equipment may be done only by qualified, authorized electricians. This applies also to repairs that are not described here.

#### Note

The documents included do not always contain the electrical schematics and pneumatic diagrams.

If you need the respective diagrams, they can be ordered from Nabertherm Service.



## 9.1 Replacing a Thermocouple



### Warning – Danger of Electric Shock

Work on the electrical equipment may be done only by qualified, authorized electricians. During work it must be ensured that the furnace and the switching equipment cannot be activated by mistake (pull out the power plug) and that all moving parts in the furnace are secured. Observe DGUV V3 or the corresponding national regulations in the country where the furnace is installed. Wait until the furnace and the connected parts have cooled to room temperature.



### Warning – General Hazards!

If installed improperly, functioning and safety of the system can no longer be guaranteed. The connection must be properly installed and put into operation by qualified personnel.



### Caution - damage to components!

Thermocouples are extremely sensitive to breakage. Any strain on or rotation of the thermocouples must be avoided. Failure to observe this rule will lead to the immediate destruction of the sensitive thermocouples.

Unscrew all the screws of the back wall with a suitable tool and keep them in a safe place for future use. Place the cover on a soft surface (such as foam rubber). The number and position of the screws may differ depending on the furnace model. The picture may differ depending on the furnace model.

First remove the two screws (A) from the thermocouple connection. Remove screw (B) and pull out the thermocouple (C).

Insert the new thermocouple carefully into the thermal channel (C), install and connect in reverse order. Make sure that the polarity of the electrical connections (D) is correct\*).

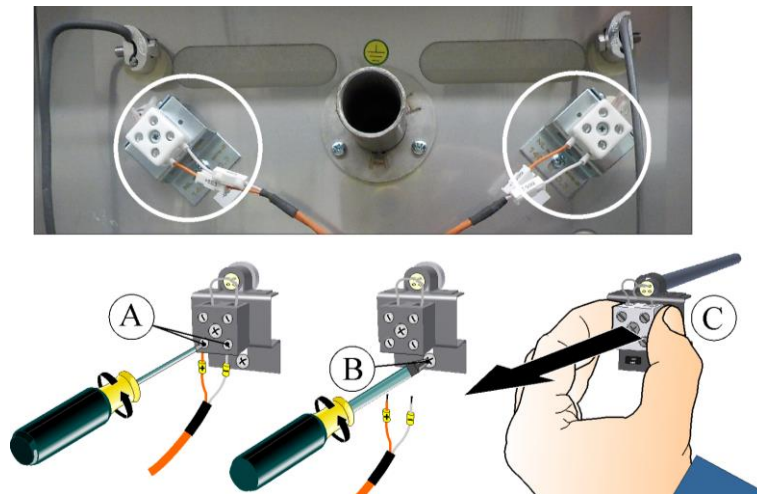


Fig. 47: Removing the thermocouple(s) (similar to picture)

### Note

\*) The connections of the connecting lines from the thermocouple to the controller are labeled with  $\oplus$  and  $\ominus$ . It is absolutely essential to observe the correct polarity.

$\oplus$  to  $\oplus$        $\ominus$  to  $\ominus$



**Note**

Make sure that all screwed and plugged connections are in working order.

## 9.2 Replacing the Heating Plates and Internal Furnace Insulation (Fiber Muffle)



You can obtain the refitting instructions (M06.0010) for replacing the internal furnace insulation (fiber muffle) and heating plates via the following link or by scanning this QR code: Apps to scan QR codes can be downloaded from the corresponding sources (app stores).

<https://nabertherm.com/en/downloads/instructions>

## 9.3 Replacement/Readjustment of the Door Insulation Structure



**Warning! General hazards!**

Work on the equipment may only be performed by qualified, authorized specialists. During work, the voltage supply to the furnace/switching system must be switched off to prevent unintentional commissioning (disconnect mains power connector) and all moving parts of the furnace must be secured. Observe DGUV V3 or corresponding national guidelines of the country of use. Wait until the furnace chamber and attaching parts have cooled to room temperature.



Carefully open the furnace door. Unscrew the screws from the door cladding (A), using the hex key that is provided and remove the cladding from the frame. Undo the screws from the door insulation (B). Pull and lift the door insulation upward from the furnace to remove it.

Tip: Swing the lift door (furnaces with lift door) a little downward, as this makes it easier to remove the door insulation.

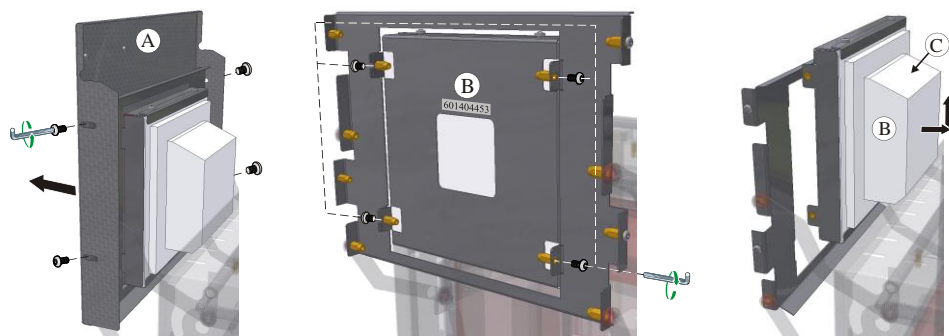


Fig. 48: Dismantling the door cladding/insulation (similar to picture)

Install the new door insulation in the reverse order. The bevel of the (C) door insulation faces upward. Screw the screws of the door insulation in loosely so that you can adjust the door insulation. Insulation is very sensitive, watch out for adjacent components. The door collar insulation (D) must sit properly on the furnace collar insulation all around. Follow the instructions below to adjust the door insulation.

Carefully close the door. Press lightly against the door insulation (1). While doing so, tighten all the screws (2).

Install the door cladding in the reverse order.

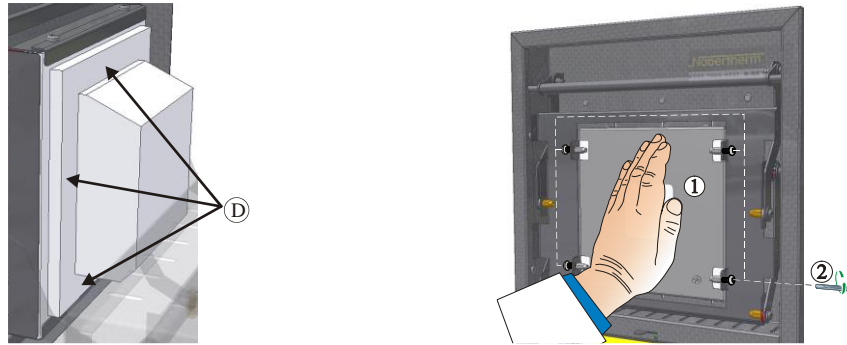


Fig. 49: Adjusting the door insulation (similar to picture)

## 9.4 Repairing the Insulation

The insulation of the furnace consists of a very high-quality refractory material. Heat expansion may cause tears in the insulation even after a few heating cycles. However, these have no affect on the function or quality of the furnace. However, if entire "sections" of the insulation come loose, Nabertherm Service must be notified.

It is quite normal that cracks appear in ceramic fiber insulation after the first firing. These cracks are usually not very deep (a few mm) and also have no effect on the function of the insulation.

Cracks generally occur due to thermal stresses that occur when the furnace is heating or cooling or because of rapid changes in temperature, such as when the door is opened at a high temperature. The temperature itself and chemical substances that may be in the material to be fired can also cause cracks.

If cracks larger than 5 mm appear in the fiber insulation or material breaks off the furnace collar or refractory door material due to mechanical damage, these cracks or missing material can be filled with a repair material. Use a small spatula or a small piece of metal plate to press the repair material into the cracks. If larger areas of material break off, the entire insulation has to be replaced. Allow the repair material to dry for 24 hours before heating the furnace.

## 9.5 Electrical Schematics/Pneumatic Schematics



### Note

The documents included do not always contain the electrical schematics and pneumatic diagrams.

If you need the respective diagrams, they can be ordered from Nabertherm Service.

## 9.6 Additional Equipment

### 9.6.1 Gas Supply System (Accessories)



Fig. 50: Connection to the gas supply system (similar to picture)

1	<b>Gas Supply System 1</b> for simple protective gas applications (no vacuum operation) This package represents a basic version sufficient for many applications, for operation with nonflammable protective gases.
2	The customer is responsible for providing the exhaust system

#### Function Description

The gas supply system permits you to feed **non-combustible** protective and reactive gases (such as: helium ( $\text{He}$ ), argon ( $\text{Ar}$ ), forming gas or nitrogen ( $\text{N}_2$ )) into a furnace in a quantity for a defined period.

#### Safety

The gas supply system must be inspected to ensure it is in perfect condition before each use. If a defect is discovered the furnace must be shut down immediately.

During operation toxic gases and vapors can be released. They must be appropriately vented out of the building. Ignoring this warning can be dangerous to your health.

Only use gases whose characteristics are known. If something unexpected happens in the furnace (for example, build up of dense smoke or noxious smells) it must be shut down immediately and you must wait until the furnace has cooled down naturally.

The use of the gas supply system in connection with combustible gases is only permissible with additional "safety devices".

- You must ensure that the installation room is well ventilated and that protective gas emissions do not present any danger.
- It is the user's responsibility to ensure compatibility with local safety and installation regulations.
- The use of the furnace for the purposes for which it was designed also requires observing the instructions contained in this operating manual for installation, start-up and maintenance.
- You must be aware of the real or potential combustibility and explosiveness of gases when they are when operating the furnace. Make sure in particular that no corrosive or health endangering substances are generated and escape into the surrounding air.

- Operating the system is prohibited with power sources, products, operating equipment, auxiliary materials, etc., which are listed as hazardous or which may in any way harm the health of the personnel operating the furnace.
- Make sure the hose connection is perfectly tight before each use.
- The gas supply system must be checked for leaks and deposits in the flow meter (use a leak detection spray if necessary).
- The functionality of the ball valve and the solenoid valve must be checked at regular intervals.

**Note**

When working with protective gases always make sure that the room is adequately ventilated. Country-specific safety regulations must also be observed.

**Note**

See additional operating instructions for description and function.

**Warning – Danger of Suffocation**

There is a danger of suffocation when process/purge or exhaust gases escape, e.g. as a result of leaks (e.g. at doors, pipes, valves, etc.).

Due to their specific weight gases can displace oxygen. This poses a danger of suffocation.

Measures: Switch on the extraction system.

## 9.6.2 Operation of Compressed Gas Containers



Pressurized gas tanks may be operated only by persons familiar with their handling. Before commencing work, employees must be instructed

in the operation of pressurized gas tanks,  
about the special hazards of handling pressurized gas tanks, and

- what to do in case of accidents or malfunctions. These instructions must be repeated at appropriate intervals.

Pressurized gas cylinders may be placed in work rooms only in the absolutely necessary quantities and in the smallest possible sizes, and only for immediate use.

Pressurized gas cylinders must not be stored in work rooms.

If possible, gas cylinders should be kept in gas cylinder cabinets with an extraction system.

When no gas is being withdrawn, always keep the main valve on the gas cylinder closed.

Gas cylinders without attached pressure regulators must not be used without protective caps. Gas hoses must be checked regularly for brittle or porous areas and, if necessary, be replaced immediately.



### Safety measures and appropriate conduct

- Secure pressurized gas tanks against toppling over, impact and heating (e.g. from heater or furnace system).
- At the workplace only have the number of pressurized gas cylinders required to continue working.
- Transport only with cylinder transport trolleys and with protective caps firmly screwed on.
- Wear suitable gloves and if necessary goggles.
- When changing cylinders, always check for leaks at the valves of full and empty cylinders.
- Refilling cylinders is prohibited.
- Do not use force to open valves.
- Sufficiently ventilate areas.
- Smoking and open flames are prohibited.
- Keep fire extinguisher ready.

The operator must prepare operating instructions specifying the hazards occurring in the work room for people and the environment and also specifying the generally required protective measures and codes of conduct. The operating instructions must be written in an understandable form and be available in the work room. The operating instructions must also contain instructions on what to do in case of danger and about first-aid measures.



#### Note

When working with protective gases always make sure that the room is adequately ventilated. Country-specific safety regulations must also be observed.



#### Warning – General Hazards!

If installed improperly, functioning and safety of the system can no longer be guaranteed. The connection must be properly installed and put into operation by qualified personnel.

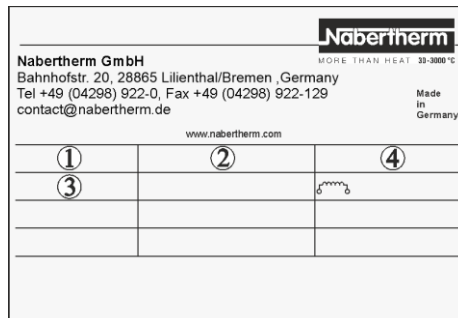
## 10 Nabertherm Service

The Nabertherm Service team is available at all times for furnace maintenance and repair. If you have any questions, problems, or requirements, contact Nabertherm GmbH. By mail, phone, or the Internet.

Mail	Phone or fax	Web or e-mail
Nabertherm GmbH Bahnhofstrasse 20 28865 Lilienthal Germany	Phone: +49 (4298) 922-333 Fax: +49 (4298) 922-129	www.nabertherm.com contact@nabertherm.de

**When you contact us, please have the type plate details of the furnace or controller at hand.**

Provide the following details from the type plate:



The type plate contains the following information:

- 1**: Furnace model
- 2**: Serial number
- 3**: Article number
- 4**: Year of construction

Additional text on the plate includes: Nabertherm GmbH, Bahnhofstr. 20, 28865 Lilienthal/Bremen, Germany, Tel +49 (04298) 922-0, Fax +49 (04298) 922-129, contact@nabertherm.de, www.nabertherm.com, and Made in Germany.

Fig. 51: Example (type plate)

## 11 Shut-Down, Dismantling, and Storage

### 11.1 Environmental Regulations

When it is delivered, this furnace contains no substances that make a hazardous waste classification necessary. However, residues of process materials may accumulate in the furnace insulation during operation. These may be hazardous to health and/or the environment.

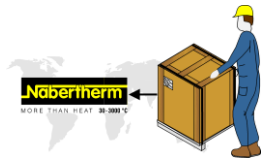
- Dismantle the electronic components and dispose of them as electric scrap.
- Remove the insulation and dispose of it as hazardous waste (see “Servicing, Cleaning, and Maintenance with Ceramic Fiber Material”).
- Dispose of the housing as scrap metal.
- Contact the responsible disposal company to dispose of the materials listed above.



**Note**

Observe the national regulations of the country in which the furnace will be used.

## 11.2 Transportation/Return Transportation



If you still have the original packaging, this is the safest way to send a furnace.

Otherwise:

Choose suitable, adequately sturdy packaging. During transportation, packages are often stacked, bumped, or dropped; the packaging acts as external protection for your furnace.

+45°C  
-5 °C



- **Drain all piping and containers before transportation/return transportation (e.g. cooling water). Pump off operating materials and dispose of properly.**
- **Do not subject the furnace to extreme cold or hot temperatures (direct sunlight)**
- **Storage temperature -5 °C to 45 ° (23 °F to 113 °F)**
- **Humidity 5 % to 80 %, non-condensing**
- **Place the furnace on a level floor to prevent distortion**
- **Packaging and transportation may be carried out only by qualified and authorized persons**

If your furnace has transportation securing equipment (see "Transportation Securing"), use this.

Otherwise, in general:

“Fix” and “secure” (adhesive tape) all moving parts and cushion and protect any projecting parts against breakage.

Protect your electronic equipment against moisture and make sure that no loose packaging material can get inside it.

Fill gaps in your packaging with soft but adequately firm material (e.g. foam mats) and make sure that the equipment cannot slide around in the packaging.

**If the goods are damaged during return transportation due to inadequate packaging or some other breach of duty, the costs will be borne by the customer.**

As a rule:

The furnace is sent without accessories, unless the technician expressly requests them.

Enclose a detailed description of the malfunction along with the furnace – this saves the technician time and costs.

Don't forget to enclose the name and phone number of a contact in case there are any questions.

### Note

Return transportation may only be carried out according to the information given on the packaging or in the transportation documents.

### Note

Transportation and return transportation **not** covered by a warranty claim are paid for by the customer.



## 12 Declaration of Conformity



### EU Declaration of Conformity

Product	Laboratory Furnaces (Muffle Furnaces)
Model	L .../... LE .../... LT .../... LV .../... LVT .../... -SKM - SW

Name and address of the manufacturer

Nabertherm GmbH  
Bahnhofstr. 20  
28865 Lilienthal, Germany

The above product fulfills the following harmonization regulations of the EU:

- 2006/42/EC (Machinery Directive)
- 2014/30/EU (EMC):
- 2011/65/EU (RoHS)

The following harmonized standards were applied:

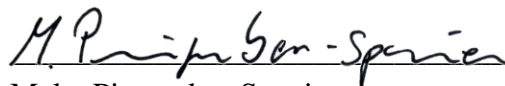
- DIN EN 61010-1 (03.2020)
- DIN EN IEC 61000-6-1 (11.2019), DIN EN IEC 61000-6-3 (06.2022)

The manufacturer has sole responsibility for issuing this declaration of conformity. The signatories of the declaration are authorized to compile the relevant technical documents. The address corresponds to the specified address of the manufacturer.

Lilienthal, 13.09.2022



Dr. Henning Dahl  
Vice President R & D



Malte Pirngruber-Spanier  
Department Manager R & D

---

## 13 For Your Notes

**For Your Notes**



MORE THAN HEAT 30-3000 °C

**Headquarters:**

Nabertherm GmbH · Bahnhofstr. 20 · 28865 Lilienthal/Bremen, Germany · Tel +49 (4298) 922-0, Fax -129 · [contact@nabertherm.de](mailto:contact@nabertherm.de) · [www.nabertherm.com](http://www.nabertherm.com)

Reg: M01.1060 ENGLISCH